

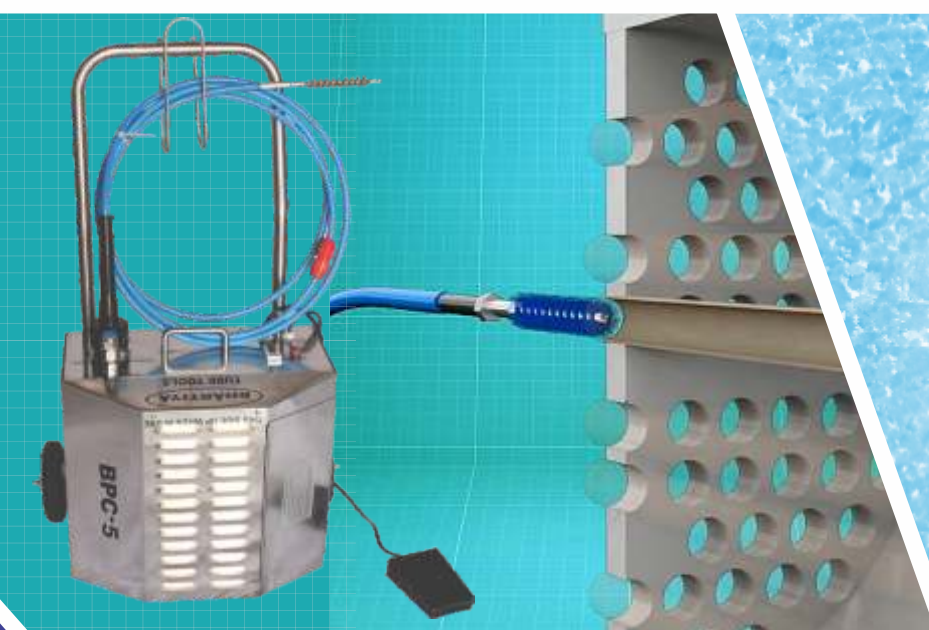

TUBE TOOLS



SHINGARE™
INDUSTRIES PVT LTD

MANUFACTURER & EXPORTER OF

Tube Cleaners, Tube Tools,
Tube Expanders, Bolting Tools, Impact Sockets,
Pipe Beveling Machines, Pipe Cold Cutting Machines,
High Pressure Water Jet Cleaning Machines & Tapping Machines

Our Successful Participation in Trade Fairs and Conventions in INDIA and Overseas.



SISSA BANGALORE 2015



SISSA, CHENNAI 2016



STAI, NEW DELHI 2016



SISSA, TIRUPATI 2017



MAHATECH, PUNE 2015

CONTENTS

Sr. No.	Product	Page
1.	Introduction	3
2.	Boiler Tube Cleaner	4 - 8
3.	Pneumatic Boiler Tube Cleaner	9 - 10
4.	Chiller / Condenser Tube Cleaner	11 - 15
5.	Pneumatic Tube Cleaner (Chocked Tube)	16-23
6.	High Pressure Water Jet Cleaner	24-25
7.	Hot & Cold Water Jetting Machine	26
8.	Boiler Tube Expander	27
9.	Condenser Tube Expander	28
10.	Tube Expansion Machines	29-30
11.	Tube Installation Tools	31
12.	Tube Removal Tools and Machine	32-34
13.	Important Note	35

Education is necessary but not a pre-requisite for success in life. Bhartiya Industries is the best example of this theory. **Mr. Suryakant Shingare** (HARIBHAI), the founder of the company is a non-matriculate technocrat with more than 10 years experience in flexible shaft manufacturing. He founded this company in 1989.



Basic Products:

Engineering products is our forte. We manufacture engineering products such as tube expander, tube cleaner, tube tools, hydraulic tube expansion, tube pulling, and pipe beveling machines. We also deal in manufacture of flexible shaft grinders, construction equipment, hydraulic torque wrench, impact socket, pneumatic tapping machines, and many more...

Brief History of the Company:



We were a small industry until 2003 engaged in production and supply of different types of flexible shafts for tube cleaning, brushes, flexible shaft grinder, and concrete vibrators. The year 2003 was a watershed year for the company.

Mr. Pradip Shingare, son of **Mr. Hari Shingare**, graduated from Mumbai University with a degree in Mechanical Engineering. He had great plans to take the company forward on the route to expansion. He ventured into export of the engineering products. By 2008, the company acquired the reputation as the largest exporter of tube cleaning machines and flexible shafts in India.

The year 2009 saw the expansion of the company into manufacture of products such as Tube expander, tube tools, and tube pulling machines. The company witnessed a record double-digit growth in this product range. In 2011, the company started developing a product range of pipe beveling machines. These machines are extremely popular in India as well as in the overseas market. The year 2013 witnessed the company foray into imports of different types of tools such as tapping tools, grinding tools, etc making us the leading player in India in these categories.

The year 2015 saw us entering into the sugar industry component with the manufacture of the Heavy Duty Sugar Dust Collector machine, FlexRepair40 machine.

In 2016, we added **SHINGARE INDUSTRIES PVT. LTD.** a new company in our group. We were awarded ISO 9001:2015 certification for strictly followed quality norms and processes.

Dedicated Staff:

We have a dedicated team of more than 40 people, many of whom are with us since the early days of the company. We have an excellent blend of youth, knowledge, and experience in our ranks.

Export oriented:

We export over 60% of our products to more than 55 countries all over the globe.

Expansion:

We feel the need to expand our business to enable us to serve the people of this country better. With this aim in mind, we established a new company in the name of SHINGARE INDUSTRIES PVT. LTD.

Our main motto of business is “Growth with Trust.”

Our mission is to innovate and create an import substitute products in India.

BOILER TUBE CLEANER



FLEXIBLE SHAFT MACHINE ('BFM' SERIES):

It is a 3 phase electric motor (2088 rpm) mounted on 3 wheel trolley fitted with a carrying trolley. Horse power of motor is selected depending upon the length & size of shaft, and type of scaling. Push button starter is provided to control the motor. Each machine is fully wired, carefully tested & fitted with a 10 ft. Length (Or longer if required) PVC cable to main supply. Motors are available in enclosed system as well as in open system (i.e. without covering of above motor.)

Please contact us if your electrical specification is different from below mentioned. Machine for alternate supply are also available.



OPEN SYSTEM



CLOSE SYSTEM

Model No.	Motor	Power	Electric Supply	Speed RPM	Tube I.D	INCH
	HP	KW			MM	
BFM-30	3	2.238	440 V 3 Phase 50 C/S A/C	2800	28.0-50.80	1.1/8"-2.0"
BFM-50	5	3.73		2800	38.10-101.6	1.1/2"-4.0"
BFM-50M	5	3.73		2800, 1400, 910	38.10-101.6	1.1/2"-4.0"
BFM-50S	5	3.73		1400	38.10-101.7	1.1/2"-4.0"
BFM-50V	5	3.73		300-2800	38.10-101.8	1.1/2"-4.0"

To view demo of above machine please visit our below youtube link https://youtu.be/q2okON5_f4I (If you cannot click below then either copy and paste the same in the browser or scan below QR code)



'BHARTIYA' FLEXIBLE SHAFTS ('BFS' SERIES):

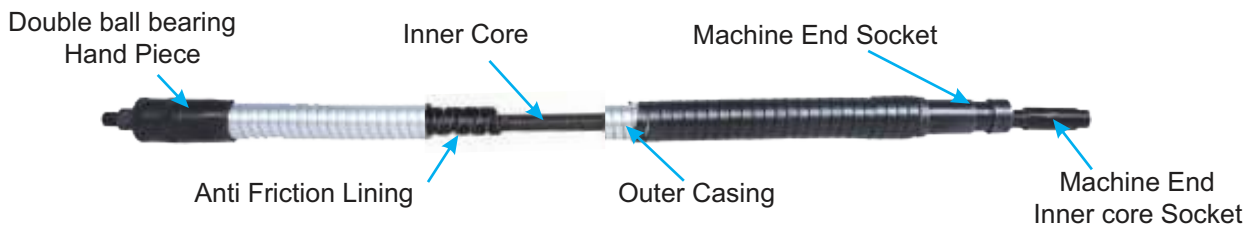

It is used for cleaning of tube by transmitting power in terms of rotation from the motor unit to tool head cutter or brush within tube.

INNER CORE :

it is flexible wire with multiple wound opposite layer. It is made of high tensile spring steel or stainless steel (as per requirement) and passed through heat treatment processes to make it absolutely vibration free.

OUTER CASING :

it is flexible, double interlocked, circular rounded, made of galvanized steel strip, Special spring steel lining is provided within outer casing to avoid any friction between inner core & outer casting.

Connection:

One end of shaft with machine and socket is attached to suitable motor and other end is attached to tool end.

For Domestic or Indian Flexible Shafts, Sizes are as follows:

1. Model: BFS-1025

Inner core: 12.5mm

Outer Casing: 33mm

2. Model: BFS-107:

Inner core: 15mm

Outer Casing: 33mm

2. Model: BFS-107:

Inner core: 18.5mm

Outer Casing: 35.5mm

Note:

Tolerance for inner cores
Are ± 0.5mm

Tolerance for outer casing
Are ± 1mm

INNER CORE DIA MM (INCH)			11.0 MM (7/16")	13 MM (1/2")	15 MM (5/8")	19.0 MM (3/4")
OUTER CASING MM (INCH)			22.0 MM (7/8")	24.0 MM (15/16")	29.0 MM (1.14")	33.0 MM (1.3")
LENGTH						
Mtrs.	Feet	Sr. No.	MODEL NO.	MODEL NO.	MODEL NO.	MODEL NO.
6.0	20.0	1	BFS-104-20	BFS-105-20	BFS-106-20	BFS-107-20
7.5	25.0	2	BFS-104-25	BFS-105-25	BFS-106-25	BFS-107-25
8.0	27.0	3	BFS-104-27	BFS-105-27	BFS-106-27	BFS-107-27
9.0	30.0	4	BFS-104-30	BFS-105-30	BFS-106-30	BFS-107-30
10.0	33.0	5	BFS-104-33	BFS-105-33	BFS-106-33	BFS-107-33
12.0	40.0	6	BFS-104-40	BFS-105-40	BFS-106-40	BFS-107-40
15.0	50.0	7	BFS-104-50	BFS-105-50	BFS-106-50	BFS-107-50
18.0	60.0	8	BFS-104-60	BFS-105-60	BFS-106-60	BFS-107-60
20.0	65.0	9	BFS-104-65	BFS-105-65	BFS-106-65	BFS-107-65
25.0	82.5	10	BFS-104-82	BFS-105-82	BFS-106-82	BFS-107-82
30.0	100.0	11	BFS-104-100	BFS-105-100	BFS-106-100	BFS-107-100
Spare Inner Core Per Meter			BIC-104	BIC-105	BIC-106	BIC-107
Spare Outer Casing Per Meter			BOC-104	BOC-105	BOC-106	BOC-107
Spare Hand Piece			BHP-104	BHP-105	BHP-106	BHP-107

TOOL HEAD CUTTER:

'CT' SERIES TOOL HEAD CUTTER:

Purpose: For rapid removal of hard scale.

Description: It has 15 cutter wheels. (4 straight) wheels, 4 left wheel, 4 right wheel & 3 bevel wheels).

They are spring loaded & self expanding.

Size: For tube I.D. From 31mm to 53mm



OPEN BODY



CLOSE BODY

Serial No.	Tube I. D.		Tool Head	Cutters Wheel Set of 15 rollers	Spare Arms
	MM	INCH			
1	31.7	1.1/4	CT-10	CTW-1	CTA-1
2	33.3	1.5/16	CT-10A	CTW-1	CTA-1
3	35.0	1.3/8	CT-11	CTW-1	CTA-1
4	36.5	1.7/16	CT-11A	CTW-1	CTA-1
5	38.1	1.1/2	CT-12	CTW-2	CTA-2
6	39.7	1.9/16	CT-12A	CTW-2	CTA-2
7	41.3	1.5/8	CT-13	CTW-2	CTA-2
8	42.9	1.11/16	CT-13A	CTW-2	CTA-2
9	44.5	1.3/4	CT-14	CTW-3	CTA-3
10	46.0	1.13/16	CT-14A	CTW-3	CTA-3
11	47.6	1.7/8	CT-15	CTW-3	CTA-3
12	49.2	1.15/16	CT-15A	CTW-3	CTA-3
13	51.0	2	CT-16	CTW-3	CTA-3

'T' SERIES TOOL HEAD CUTTER:



'T' Series:

Purpose: For cleaning straight and curved tubes as found in boiler, air heaters.

Description: This head cutter is provided with three wheels, one each of straight teeth, teeth cut right hand, teeth cut left hand for quicker cleaning and to prevent gtooving of scale.

Size: Tube I.D From 31mm to 102mm

NOTE: '2Layer & 3 Layer tool head cutters also available in 'T' series cutters.



Serial No.	Tube I. D.		Tool Head Model No.	Cutters Wheel Set of 3 rollers Model No.	Spare Arms Model No.
	MM	INCH			
1	31.7	1.1/4	T-10	TW-1	TA-1
2	35.0	1.3/8	T-11	TW-1	TA-1
3	38.1	1.1/2	T-12	TW-1	TA-1
4	41.3	1.5/8	T-13	TW-2	TA-2
5	44.5	1.3/4	T-14	TW-2	TA-2
6	47.6	1.7/8	T-15	TW-2	TA-2
7	51.4	2	T-16	TW-2	TA-2
8	54.0	2.1/8	T-17	TW-2	TA-2
9	57.1	2.1/4	T-18	TW-3	TA-3
10	63.5	2.1/2	T-20	TW-3	TA-3
11	70.0	2.3/4	T-22	TW-4	TA-4
12	76.2	3	T-24	TW-4	TA-4
13	82.5	3.1/4	T-26	TW-5	TA-5
14	88.9	3.1/2	T-28	TW-5	TA-5
15	95.2	3.3/4	T-30	TW-6	TA-6
16	101.6	4	T-32	TW-6	TA-6

'YT' SERIES TOOL HEAD CUTTER:

'YT' Series:

Purpose: For fine cleaning of curved or bend tubes.

Description: It has pivpted arms and cutter head which contacts every part of tube due to centrifugal force.

Size: For tube I. D. From 32mm to 102mm



Serial No.	Tube I. D.		Tool Head Model No.	Cone Cutter Set of 3 rollers Model No.	Spare Arms Model No.	Universal Joint Model No.
	MM	INCH				
1	38.1	1.1/2	YT-12	YTC-12	YTA-12	YTUJ-12
2	44.5	1.3/4	YT-14	YTC-14	YTA-14	YTUJ-14
3	51.4	2	YT-16	YTC-16	YTA-16	YTUJ-16
4	57.1	2.1/4	YT-18	YTC-18	YTA-18	YTUJ-18
5	63.5	2.1/2	YT-20	YTC-20	YTA-20	YTUJ-20
6	69.8	2.3/4	YT-22	YTC-22	YTA-22	YTUJ-22
7	76.2	3	YT-24	YTC-24	YTA-24	YTUJ-24
8	88.9	3.1/2	YT-28	YTC-28	YTA-28	YTUJ-28
9	101.6	4	YT-30	YTC-30	YTA-30	YTUJ-30

TOOL HEAD CUTTER

'SA' TYPE CUTTER HEADS



Model No.	Tube I.D.		Cone & Flat Cutter Set (9) Model No.	Arms Model No.	Universal Joint Model No.
	MM	INCH			
SA-16	51.0	2	SAFC-1	SAA-1	SAUJ-1
SA-18	57.1	2.1/4	SAFC-2	SAA-2	SAUJ-2
SA-20	63.5	2.1/2	SAFC-2	SAA-2	SAUJ-2
SA-22	70.0	2.3/4	SAFC-3	SAA-2	SAUJ-2
SA-24	76.2	3	SAFC-3	SAA-2	SAUJ-2
SA-28	88.9	3.1/2	SAFC-4	SAA-2	SAUJ-2
SA-32	101.6	4	SAFC-5	SAA-3	SAUJ-2

For Tubes / Pipes 2"-4" (51.0mm-101.6mm) I.D. These cutter Heads have 3 to 5 freely pivoted arms, activated centrifugally, which swing out to give access to any part of tube well.

CARBIDE DRILL

Carbide Drills used for cleaning tubes choked solidly with hard deposits. Size 1/4m (6.4m) - 2 1/4 (50.8mm)



CARBIDE DRILL

"P" & "TC" TYPE

The model "P" & "TC" cutter head is used for cleaning straight tubes from 1-1/2" I.D. through 7" I.D. It is usually direct coupled to drive motor but flexible couplings, universal joints or flexible holders, are used to negotiate curved or bend tubes.

The model "P" & "TC" is for heavy and hard tube deposits as found in refinery and still tubes. It is tough in its parts and assembly as necessary to stand up in this service and it makes economical provision, as described below, for inevitable wear due to large forces which must transmit through the assembly. The model "P" & "TC" is conformed to do its work quickly and thoroughly even when deposits are of varying thickness and hardness.



'P' & 'TC' TYPE

Cone cutter, with tapered cutting edges at the front of the cutter head, expand against tube deposits by centrifugal force and break up uneven shoulders of scale. This is followed by long rows of expanding "no track" cutter wheels which finish up with thorough, repeated cuts. Centrifugal force assures good working contact between tube deposits and cutting edges and "no track" means that cutters cannot fall into a pattern which skips over and leaves strips of scale behind.

The expansion range (range of cutter head diameters) of these cutter heads is considerable (See chart below.) and is due to (1) slotted cutter pin bearing bores and (2) intentional "Play" in pin bearing inserts, features which include an economical bonus.

Model No.	Tube I.D. INCH	Minimum Dia. Over Cutter INCH	Minimum Dia. Over Cutter INCH	Cone Cutter Set Model No.	Cylinder Cutter Set Model No.	Cutter Pin Set Model No.
TC-14	1.1/2	1.3/8	1.23/32	1787-1	1788-2	1584-1
TC-11	1.3/4	1.5/8	2	1587-1	1588-2	1584-1
TC-17	1.7/8	1.11/16	2	2287-3	2288-6	1584-3
TC-16	2	1.13/16	2.3/16	1787-3	1788-6	1584-PY
TC-13	2.1/8	1.15/16	2.5/16	1787-3	1788-6	1584-PY
P-15	2.1/4	2.1/16	2.7/16	2487-3	3338-6	2484-PY
P-9-S	2.3/8	2.3/16	2.11/16	C52-3	C76-6	2484-3
P-9	2.1/2	2.1/4	2.13/16	1587-3	1588-6	1584-PY
P-8	2.5/8	2.9/16	2.7/8	1087-3	1088-6	184-3
P-7	2.3/4	2.9/16	2.15/166	1087-3	1088-6	184-3
P-6-A	3	2.11/16	3.1/8	1087-3	1088-6	184-3

Note : Maximum Size of P&TC Cutter is up to 7".

WIRE BRUSHES



TUBE TOOLS



Female Threading

TURK HEAD BRUSH

Max. Brush Size: 6" (152.4mm)
Purpose: For removal of light scale from pan, evaporator, juice heaters tube.



DOUBLE SPIRAL BRUSH

"BDS" for removing light scale and burnishing all types of tubes



CIRCULAR WHEEL BRUSH

Max. Brush Size: 6" (152.4mm)
Thickness: 1/2" to 2"
Purpose: For polishing, deburring & cleaning of tube



"WBA" HEAVEY DUTY BRUSH

It can be used along with 15 roller tool head cutter for quick cleaning size 1/4" to 4"



SPRING COIL BRUSH

Max. Brush Size: 38.1mm upto 152.4 mm I/D
Purpose: For heavy duty tube cleaning.



"EXS" EXPANDING SCRAPPERS
 For thin scale, soot or soft deposits

SR. No.	Size		'BT' Turk Head Brush Model No.	'BDS' Double Sprial Brush Model No.	'BCW' Circular Wheel Brush Model No.	'WBA' Shuttle Cock Brush Model No.	'BSC' Spring Coil Brush Model No.	'EXS' Expanding Scrapper Brush Model No.
	MM	INCH						
1	31.7	1.1/4	BT-10	BDS-10	BCW-10	WBA-10	---	EXS-10
2	35.0	1.3/8	BT-11	BDS-11	BCW-11	WBA-11	---	EXS-11
3	38.1	1.1/2	BT-12	BDS-12	BCW-12	WBA-12	BSC-12	EXS-12
4	41.3	1.5/8	BT-13	BDS-13	BCW-13	WBA-13	BSC-13	EXS-13
5	44.5	1.3/4	BT-14	BDS-14	BCW-14	WBA-14	BSC-14	EXS-14
6	47.6	1.7/8	BT-15	BDS-15	BCW-15	WBA-15	BSC-15	EXS-15
7	50.8	2	BT-16	BDS-16	BCW-16	WBA-16	BSC-16	EXS-16
8	54.0	2.1/8	BT-17	BDS-17	BCW-17	WBA-17	BSC-17	EXS-17
9	57.1	2.1/4	BT-18	BDS-18	BCW-18	WBA-18	BSC-18	EXS-18
10	60.3	2.3/8	BT-19	BDS-19	BCW-19	WBA-19	BSC-19	EXS-19
11	63.5	2.5/8	BT-20	BDS-20	BCW-20	WBA-20	BSC-20	EXS-20
12	66.7	2.5/8	BT-21	BDS-21	BCW-21	WBA-21	BSC-21	EXS-21
13	69.8	2.3/4	BT-22	BDS-22	BCW-22	WBA-22	BSC-22	EXS-22
14	73.0	2.7/8	BT-23	BDS-23	BCW-23	WBA-23	BSC-23	EXS-23
15	76.2	3	BT-24	BDS-24	BCW-24	WBA-24	BSC-24	EXS-24
16	79.4	3.1/8	BT-25	BDS-25	BCW-25	WBA-25	BSC-25	EXS-25
17	82.5	3.1/4	BT-26	BDS-26	BCW-26	WBA-26	BSC-26	EXS-26
18	85.7	3.3/8	BT-27	BDS-27	BCW-27	WBA-27	BSC-27	EXS-27
19	88.9	3.1/2	BT-28	BDS-28	BCW-28	WBA-28	BSC-28	EXS-28
20	92.1	3.5/8	BT-29	BDS-29	BCW-29	WBA-29	BSC-29	EXS-29
21	95.2	3.3/4	BT-30	BDS-30	BCW-30	WBA-30	BSC-30	EXS-30
22	98.4	3.7/8	BT-31	BDS-31	BCW-31	WBA-31	BSC-31	EXS-31
23	101.6	4	BT-32	BDS-32	BCW-32	WBA-32	BSC-32	EXS-32

PNEUMATIC BOILER TUBE CLEANERS FOR BOILERS & HEAT EXCHANGER TUBES



6000 SERIES AIR MOTOR

Powerful short design of Air Motor is ideal for negotiating short radius bends when cleaning curved tubes. Precision slip-fit motor construction means no special tool required for assembly and disassembly. Thrust plate motor packs plenty of power to operate all types of cleaning heads. Shown with forward swing arm type cleaner head and universal joint.

6300 SERIES AIR MOTOR

Thrust plate type motor specially designed for straight tubes motor parts slip-fit together for easy assembly without special tools. The motor operates at full power for high speed, heavy duty performance.

Sr. No.	Tube ID		Bend Tube Model	Straight Tubes Model
	MM	INCH		
1	22.0-24.0	7/8-61/64	B6024	B6324
2	25.0-29.0	1-1.5/32	B6029	B6329
3	30.0-35.0	1.3/16-1.25/64	B6035	B6335
4	36.0-41.0	1.27/64-1.21/32	B6041	B6341
5	42.0-50.8	1.5/8-2	B6051	B6351
6	50.8-57.1	2-2.1/4	B6057	B6357
7	57.1-63.5	2.1/4-2.1/2	B6063	B6363
9	63.5- 69.9	2.1/2-2.3/4	B6069	B6369
10	69.9-76.2	2.3/4-3	B6076	B6376
11	76.2-88.9	3.-3.1/2	B6088	B6388
12	88.9-101.6	3.1/2-4	B6101	B6401
12	101.6-127.0	4-5	B6127	B6427

To view demo of above machine please visit our below youtube link <https://youtu.be/IF3KukjFGbQ> (If you cannot click below then either copy and paste the same in the browser or scan below QR code).



FEATURES

- The safe way to remove tough deposits form curved or straight tubes.
- Standard models available for 19 to 140 mm I.D. On request, BHARTIYA can supply heads for up to 500mm I.D. tubes.
- Recommended for all places where danger of explosion exists.
- Air-drive rotary motor 3000-6000 RPM under no load. No overheating Efficient. Very durable.
- Automatic cut-out with torque overload prevents tube wall damage.
- Self-cleaning heads. Air blast clears away loose scale;cools cutters heads.
- Versatile range of standard cutters.
- Air motor have a simle design with few moving parts, which provide trouble free operation with minimum of maintenance.

GENERAL ARRANGEMENT FOR PNEUMATIC TUBE CLEANER SYSTEM

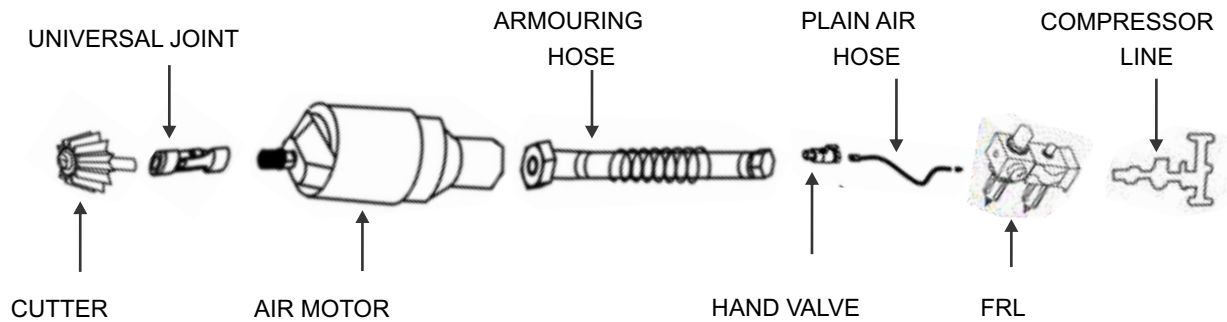

ACCESSORIES FOR TURBINE STYLE TUBE CLEANERS



Armoured Hose

Armoured Hose is connected between spiral steel wire winding throughout the hose length.



Plain Hose :

It is located between Hand Valve, FRL / Compressor line. Standard length of plain hose is 10 meter.



Hand Valve :

Hand Valve is device for controlling air pressure supply.



Circular Brush

Circular Brushes are more popular brushes with Air Motor. These brushes are connected to Air Motor by using either flexible extension or universal joint. The purpose of this brush for polishing, deburring and cleaning of tube



Flexible Extension :

It is compact device mainly used for bend/straight tube cleaning.



FRL :

The main purpose of Filter Regulator Lubricator is filter compressed air, regulates its pressure and lubricate it with oil to protect inside parts of Air Motor from rusting.



Universal Joint

It is small tool connected between air motor and circular brush for vertical straight tube cleaning.

ABOVE TUBE CLEANING SYSTEM IS ALSO KNOWN AS PIPE CUTTING EQUIPMENT OR ALUMINUM SIPHON TUBE CLEANERS.

ELECTRIC TUBE CLEANERS ('BPC-5' SERIES)

In **Electric Tube Cleaner**, the brushes or other cleaning tools are rotated through a tube at tip of flexible shaft. Simultaneously water gets injected, hence loosen deposits leaving tubes cleaned. Flexible shafts ensure use in bent tubes.

1. All models consist of tool storage box, single direction foot switch, mobile dolly.
- 2 direction foot switch is optional.

• **All units are available with following specifications**

115v 60Hz, 115v 50Hz - 9 Amps
220v 60Hz, 220v 50Hz - 4.5 Amps

• **While ordering, please mention electric specification**

Model No.	Motor		Tube ID		Speed RPM
	HP	KW	INCH	MM	
BPC-3	0.75	0.56	1/4 -1	6.4 - 25.40	910
BPC-4	1.00	0.75	1/4 -1.1/4	6.4 - 31.75	910
BPC-4S	1.00	0.75	1/4-1	6.4-25.40	1440
BPC-5	2.00	1.50	1/4-1.1/2	6.4-38.10	910
BPC-6	2.00	1.50	1/4-1.1/4	6.4-31.75	1440

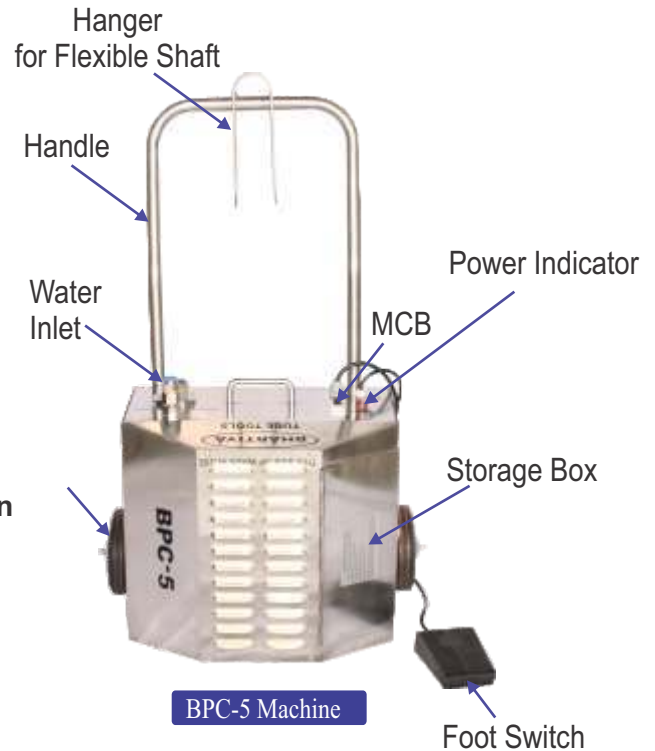

BPC-5 Machine

To view demo of above machine please visit our below youtube link https://youtu.be/aVPd_lfdjng (If you cannot click below then either copy and paste the same in the browser or scan below QR code)



PORTABLE TUBE CLEANER : ('BPC-P' SERIES)

BPC-P is a portable machine which can be carried by technician on the move. Flexible shaft rotates at speed of 1740 rpm and water gets injected simultaneously through the nylon casing to the cleaning tool. As the tool removes the deposits, the water flow flushes them out. A solenoid valve ensures that water flows only when machine is running.

• All units are available with following specifications :

115 v 60 Hz, 115 v 50 Hz - 9 Amps
220 v 60 Hz, 220 v 50 Hz - 4.5 Amps

• **While ordering, please mention electric specification**

Model No.	Motor		Tube ID		Speed RPM
	HP	KW	INCH	MM	
BPC-P	0.50	0.40	1/4 -1	6.4 - 25.4	1440
BPC-P1	1.00	0.75	1/4 -1	6.4 - 25.4	1440



BPC-P Machine

To view demo of above machine please visit our below youtube link <https://youtu.be/Cvuk-ksSnuk> (If you cannot click below then either copy and paste the same in the browser or scan below QR code)



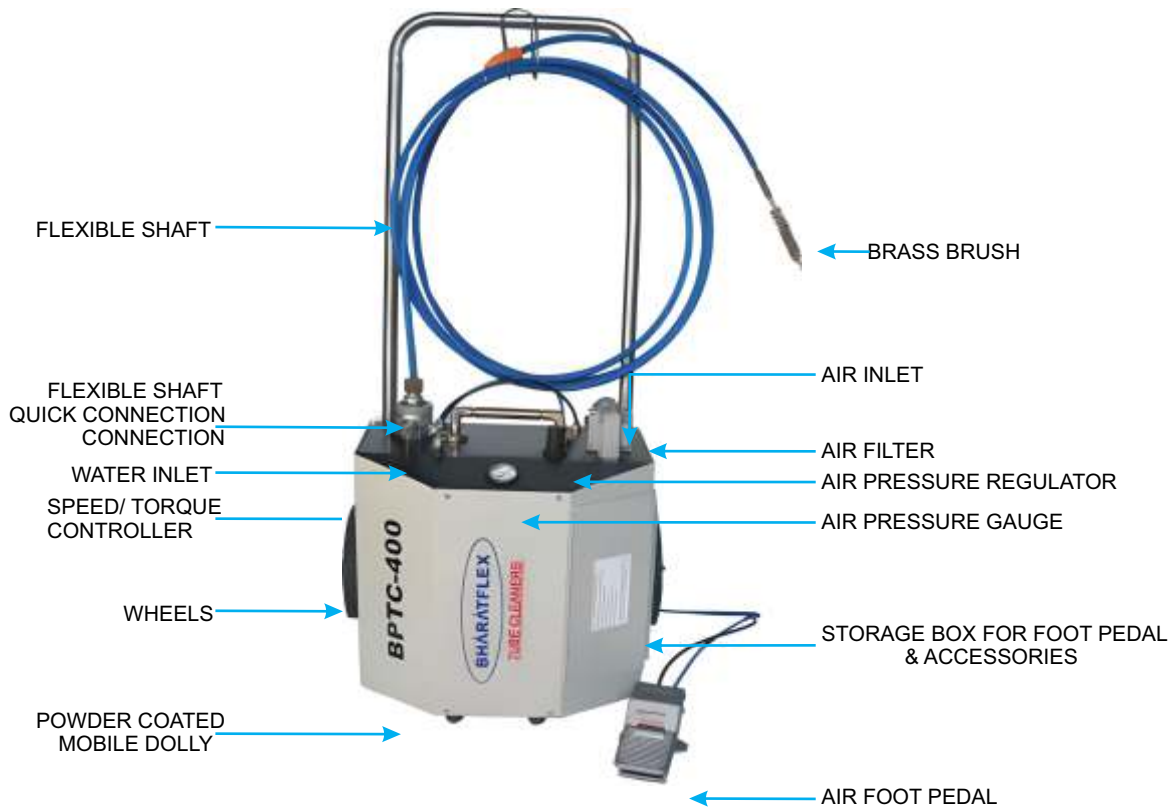

Features

- Shock Resistant - Excellent for applications where using electric equipment is hazardous.
- Speed/Torque control - Shaft rotation can be set at optimum speed for each application.
- Versatile - Interchangeability of different size flexible shaft and cleaning tools
- No Tooling - Quick disconnect for flexible shafts.
- Easy maneuverability - Large Wheels.
- Cleanliness - Foot pedal for operator convenience to activate shaft rotation and water flow to reduced water consumption and cleaner working area.
- Time Saving - Simultaneous water flush to remove deposits from tubes.

NOTE: As per the customer requirement, we can provide the machine with Stainless Steel Cover & Chasis

- **BHARTIYA Model BPTC-400** Extra Heavy Duty Pneumatic Tube Cleaners Machine includes lubricator, regulator, air filter, adjustable speed/torque control, mobile dolly, air foot pedal and tool storage box.
- **The BPTC -400** uses a cleaning tool mounted to the tip of a flexible shaft, which is available in different lengths and diameters to fit the size of the tube to be cleaned. For wet applications as the shaft rotates inside at watertight nylon casing, the unit feeds water through the casing to the cleaning tool. A foot pedal controls shaft rotation and flow. while the operator feeds the rotating shaft assembly through the tube, the water flushes out deposits as they are loosened.

Tube I.D		Tube Cleaner Model No.	Motor Power		Motor Speed RPM	Air Supply		Weight		Dimension		
MM	INCH		HP	KW		Min	Max	LBS.	KG.	HIGH	WIDE	DEEP
6.4 - 38.1	1/4" - 1.1/2"	BPTC-400	4	3	0-3000	60psi @ 15cfm	90psi @ 70cfm	66	30	38"(975mm)	22"(560mm)	16"(406mm)

To view demo of above machine please visit our below youtube link https://youtu.be/Tfl_0u4z_yLA (If you cannot click below then either copy and paste the same in the browser or scan below QR code)



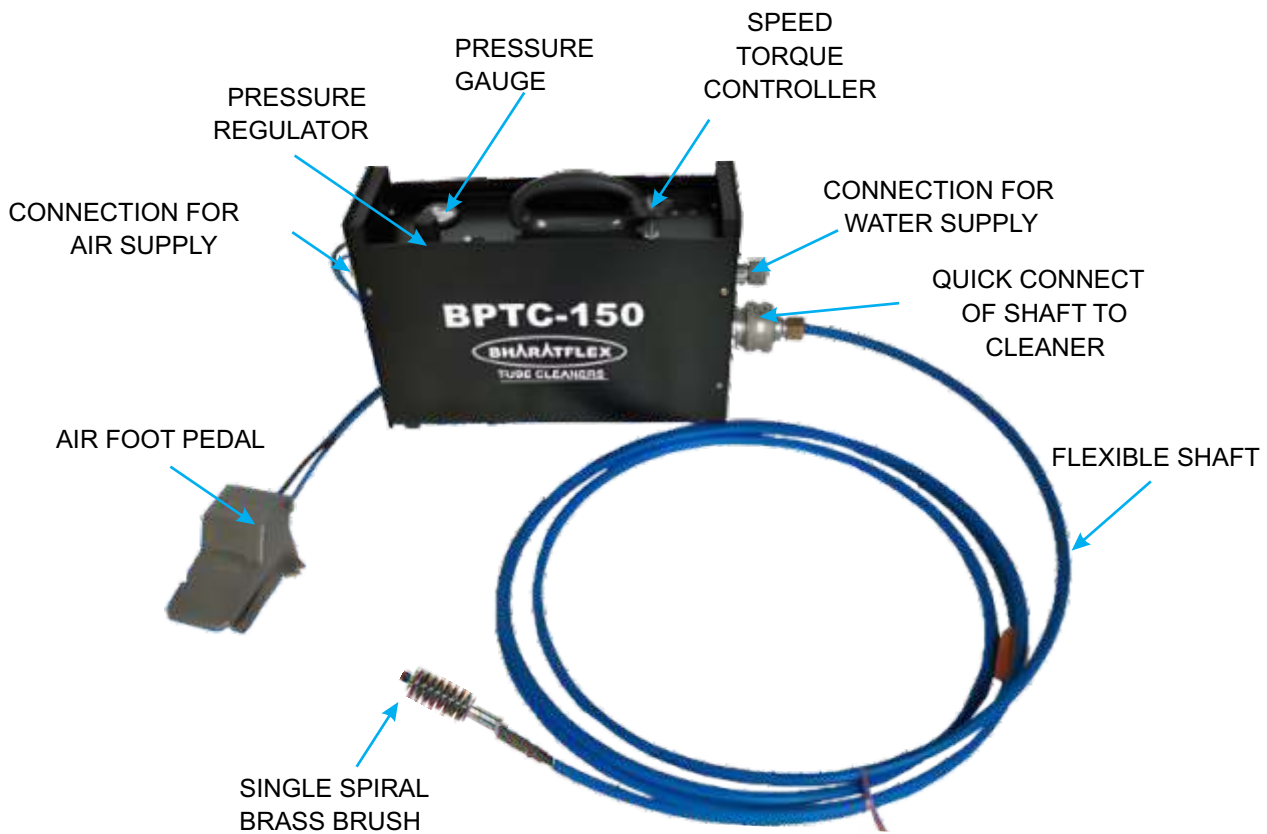

Features

- Shock Resistant - Excellent for application where using electric equipment is hazardous.
- Versatile - Interchangeability of different size flexible shafts and cleaning tools.
- Speed/Torque control - Shaft rotation speed can be set at optimum for each application.
- No Tooling - Quick disconnection for flexible shaft.
- Time saving - Simultaneous water flush to remove deposits from tubes
- Cleanliness - Foot pedal for operator's convenience to activate both shaft rotation and water flow to reduced water consumption and making working area clean.
- Compact - Light weight easy to operate inside drum.

Model-**BPTC-150** Portable Pneumatic Tube Cleaning Machine includes **FRL** unit, adjustable speed control or torque control, and air foot pedal. The **BPTC-150** uses a cleaning tool mounted on the tip of a flexible shaft, which is available in different lengths and diameter to fit the size of the tube to be cleaned. For wet applications as the shaft rotates inside its watertight nylon casings, the unit feeds water through the casing to the cleaning tool.

A foot switch controls shaft rotation and water flow. While the operator feeds the rotating shaft assembly through the tube, the water flow softens the deposits before cleaning and flushes them out during cleaning.

Tube I.D		Tube Cleaner Model No.	Motor Power		Motor Speed	Air Supply		Weight		Dimension		
MM	INCH		HP	KW	RPM	Min	Max	LBS.	KG.	HIGH	WIDE	DEEP
6.4 & UP	1/4 & UP	BPTC-150	1.5	1	0-3000	60 psi @ 15cfm	90 psi @ 70cfm	33	15	10.3/8" (264mm)	6" (150mm)	19" (483mm)

ELECTRIC TUBE CLEANERS: ('BPC-4-DUO' SERIES)

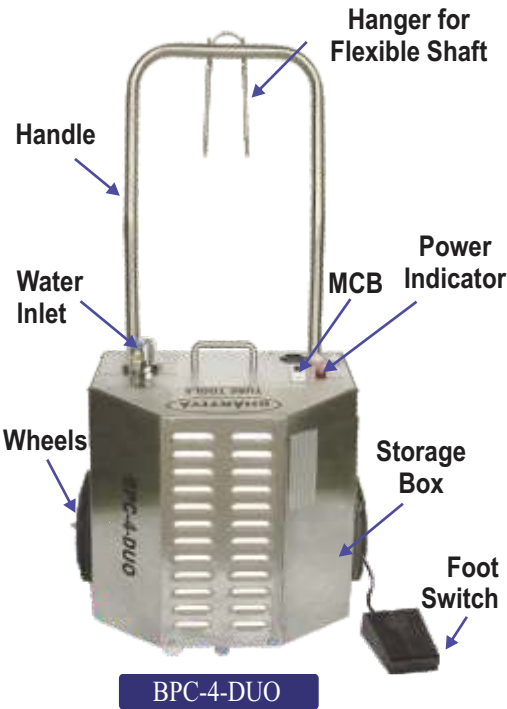

In order to clean internally enhanced tube of chiller efficiently, we introduced new series of electrically operated chiller tube cleaner machine with be directional foot switch & stainless steel mobile trolley. All our foot switches are air operated.

2 directiona foot switch is optional.

All units are available with following specifications:

- 115v60Hz, 115v50Hz-9Amps
- 220v60Hz, 220v50Hz-4.5Amps
- While ordering, please mention electric specifications.

Model No.	Motor		Tube ID		Speed
	HP	KW	INCH	MM	RPM
BPC-4-DUO	1.0	0.75	1/4 -1	6.4-25.40	1440

FLEXIBLE SHAFTS:

For BPC-2 & BPC-3, Flexible Shaft with stainless steel inner core can be supplied if specified by client.

While ordering flexible shaft and accessories, each item should be ordered for specific tube/pipes size range.

Stainless steel inner core ensures our shafts have longest life, resistance to corrosion.

To order flexible shaft (s) determine tube I.D. & Length of longest tube (s). Order flexible shaft (s) to correspond with tube I.D.(s), & length. Please ask for special or longer length.



Tube ID range		Flexible Shaft Model No.	Flexible shaft Length		Nylon Casing O.D.		Inner Core O.D.		Tool End Thread
MM	INCH		FEET	MTRS.	INCH	MM	INCH	MM	
6.4-9.5	1/4-3/8	NFSC-701-12	12	3.7	1/4	6.4	1/8	3.2	8-32 F
		NFSC-701-25	25	7.6					
11.1-12.7	7/16-1/2	NFSC-702-12	12	3.7	3/8	9.5	1/4	6.4	1/4-28 F
		NFSC-702-17	17	5.2					
		NFSC-702-25	25	7.6					
		NFSC-702-35	35	10.7					
		NFSC-702-45	45	13.7					
14.3-25.4	9/16-1	NFSC-703-12	12	3.7	1/2	12.7	5/16	7.9	1/4-28 F
		NFSC-703-17	17	5.2					
		NFSC-703-25	25	7.6					
		NFSC-703-35	35	10.7					
		NFSC-703-45	45	13.7					
		NFSC-703-60	60	18.3					
22.1-38.1	7/8-1.1/2	NFSC-705-12	12	3.7	3/4	19.1	1/2	12.7	1/2-12 F
		NFSC-705-25	25	7.6					
		NFSC-705-35	35	10.7					
		NFSC-705-45	45	13.7					

FLEXIBLE SHAFTS

(Dry Application -Steel Casing) (25.4mm) I.D.and UP for tubes 1"

Tube I.D. Range		Flexible Shaft Model No.	Flexible Shaft Length		Steel Casing O.D.		Shaft Core O.D.		Tool End Thread
MM	INCH		FEET	MTRS	MM	INCH	MM	INCH	
25.4 and up	1 and up	BFSC-706-12	12	3.7	22.2	7/8	12.7	1/2	1/2 - 12F
		BFSC-706-25	25	7.6					
		BFSC-706-35	35	10.7					
		BFSC-706-45	45	13.7					



FLEXIBLE SHAFT

FLEXIBLE SHAFTS REPAIR / MAINTENANCE

For NFSC-7 01, NFSC-702, NFSC-703 NFSC-704, NFSC-705 Flexible Shafts.

SHAFT REPAIR COUPLINGS

The life of flexible shafts can be extended by proper use and maintenance. If a flexible shaft should break at either end it can be easily repaired by cutting off the end portion and using a shaftrepair tool to attach a coupling onto the cut shaft.

Flexible Shaft Model	NFSC 701 / 702 / 703 / 705
Tool Coupling	TC-703
Casing Nipple	CN-703
Manifold Cap	MC-703
Shaft Washer	9/16x7/8
Drive Coupling	DC-703
Rubber Gasket	RG-703

For, NFSC-701, NFSC-702, NFSC-703, NFSC-704, NFSC-705 FLEXIBLE SHAFT

Flexible Shaft

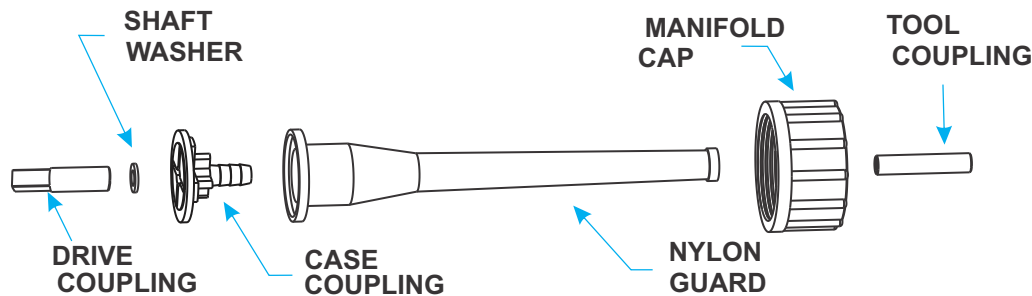

MODEL BPC4-45 CHILLER TUBE CLEANING SYSTEM:

Model No. BPC4-45 chiller tube cleaning system uses a 3/4 HP motor for tougher deposits. Single direction foot switch is provided for cleaning internally enhanced tubes.

CONTENTS:

- BPC-4 Tube cleaners-1
 - Nylon Brush (Specify size)-25
 - NFSC- 703-45 Flexible Shafts-2
 - Single Direction Air Foot Switch-1
- Repairing kit for flexible shaft NFSC-703 consisting of 4 drive couplings, 4 tool end couplings, 1 crimping tool with punch, 1 flexible shafts lubricator and 2 bottles of lubricant Tubes.



BPC-4 Tube Cleaners



Flexible Shaft



Crimping Tool



Repair Kit

PNEUMATIC TUBE CLEANER (CHOKED TUBE)



CHOKED TYPE PNEUMATIC TUBE CLEANERS



- Portable pneumatic tube cleaners use hollow aircraft quality shafts of different diameters as per tube I.D. to be cleaned which can be coupled together to form the length of the tube to be cleaned.
- Water flows through the hollow tube & flushes out deposits that are loosened by the cleaning tools attached to the hollow shaft. Tools used for cleaning are carbide drills, for severely clogged tubes, brushes for light deposits & buffing tools for final polishing. The rotation of the air motor & the water flow are controlled independently.

Model No.	Motor Power		Tube ID		Speed RPM	Air Supply		Water Supply		Weight	
	HP	KW	INCH	MM		Min.	Max.	Min.	Max.	LBS.	KG.
BC - 20	0.6	0.45	3/16-1/2	4.8-12.7	700	60psi@16cfm	90psi@16cfm	30psi	100psi	5.72	2.6
BC - 750	1.2	0.90	1/4-2	6.40 - 51.0	1000	90psi@20cfm	90psi@40cfm	30psi	100psi	6.60	4.0

- Model BC-20 is generally used for oil coolers, small heat exchanger and condenser.
- Model BC-750 is generally used for large diameter tubes of process equipment condensers and heat exchangers.

PORTABLE PNEUMATIC TUBE-2 CLEANER ACCESSORIES

- **Hollow Drive Shaft** - 4ft. (1.2m) long aircraft quality steel shafts to connect to drive. Model DS-300 to DS-500 Model DS-562 to DS-750
- **Hollow Drive Shaft** - 4ft. (1.2m) long aircraft quality steel shafts to connect to drive shafts. Order quantities based on length of tube to be cleaned. Model DN-300 to DS-500 Model DN-562 to DS-750
- **Drive Coupling** - To couple hollow drive shaft to drive. Model DC-300 to DS-500 Model DC-562 to DS-750
- **Shaft Coupling** - To couple 2 hollow shafts together. Model SC-300 to SC-500 Model SC-562 to SC-750
- **Starter Drill** - To make pilot holes in deposits of completely clogged tubes. Model SD-312 to SD-500 Model SD-562 to SD-750



CLEANING TOOLS SUCH AS NYLON/ BRASS/ SS SINGLE SPIRAL BRUSHES, BUFFING TOOLS, CARBIDE DRILLS ARE USED WITH CHOKED TYPE PNEUMATIC TUBE CLEANERS.

Tube I.D.'s suited for		Drive Model No.	Hollow Drive Shaft Model No.	Hollow Drive Shaft Model No.	Hollow Drive Shaft Model No.	Shaft Coupling Model No.	Starter Drill Model No.
mm	inch						
9.5	3/8	C-10	DS-300	DN-312	DC-312	SC-312	SD-312
11.1	7/16		DS-375	DN-375	DC-375	SC-375	SD-375
12.7-14.3	1/2-9/16		DS-437	DN-437	DC-437	SC-437	SD-437
15.9-17.5	5/8-11/16		DS-500	DN-500	DC-500	SC-500	SD-500



To view demo of above machine please visit our below youtube link <https://youtu.be/d5o0KBIXWeQ>
 (If you cannot click below then either copy and paste the same in the browser or scan below QR code)



CLEANING ACCESSORIES FOR TUBE CLEANERS

BRUSHES

NYLON BRUSHES

Used for removing soft deposits in straight non-ferrous tubes (copper, plastic, etc.)



Nylon Brush

BRASS BRUSHES

Used for removing soft and light scale deposits in straight, non-ferrous tubes.



Brass Brush

STAINLESS STEEL BRUSHES

Used for removing soft and light scale deposits in straight ferrous tubes. (carbon steel, stainless steel, etc.)



Stainless Steel Brush

- Brush should be equal to or 1/16" (1.6mm) smaller than tube I.D.
- 9/16" - 1" (14.3-25.4mm) brushes can be used for both clockwise and counterclockwise rotation.

Brush O.D.		Nylon Brush	Stainless Steel	Brass Brush	Threading	Coupling
INCH	MM					
1/4	6.4	SSB-N-204	SSB-SS-204	SSB-B-204	8 - 32F	P-1 (8 - 32M x 8 - 32M)
5/16	7.9	SSB-N-205	SSB-SS-205	SSB-B-205	8 - 32F	P-1 (8 - 32M x 8 - 32M)
3/8	9.5	SSB-N-206	SSB-SS-206	SSB-B-206	12 - 24F	P-2 (8 - 32M x 12 - 24M)
7/16	11.1	SSB-N-207	SSB-SS-207	SSB-B-207	1/4 - 28M	-
1/2	12.7	SSB-N-208	SSB-SS-208	SSB-B-208	1/4 - 28M	-
9/16	14.3	SSB-N-209	SSB-SS-209	SSB-B-209	1/4 - 28M	-
5/8	15.9	SSB-N-210	SSB-SS-210	SSB-B-210	1/4 - 28M	-
11/16	17.5	SSB-N-211	SSB-SS-211	SSB-B-211	1/4 - 28M	-
3/4	19.1	SSB-N-212	SSB-SS-212	SSB-B-212	1/4 - 28M	-
13/16	20.6	SSB-N-213	SSB-SS-213	SSB-B-213	1/4 - 28M	-
7/8	22.2	SSB-N-214	SSB-SS-214	SSB-B-214	1/4 - 28M	-
15/16	23.8	SSB-N-215	SSB-SS-215	SSB-B-215	1/4 - 28M	-
1	25.4	SSB-N-216	SSB-SS-216	SSB-B-216	1/4 - 28M	-

DRILL TIP DOUBLE DIAMETER BRUSHES

These brushes are used to clean internally enhanced tubes. The drill tip of brushes cleans through hard scale before the brush cleaning action takes over. The large diameter of this brush cleans into the grooves of the tubes and the small diameter into the lands of the tube's rifling.

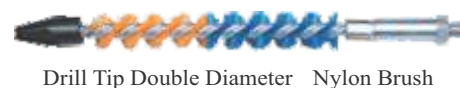

Drill Tip Double Diameter Nylon Brush



Drill Tip Double Diameter Brass Brush

Tube I.D.		Drill Tip Nylon Brush	Drill Tip Brass Brush
INCH	MM		
5/8	15.9	DTBN-625	DTBB-625

SPIN-GRIT BRUSHES



Spin-Grit Brush

Tube I.D.		Spin-Grit Brushes
INCH	MM	
1/4-3/8	6.4-9.5	BSGB-050
7/16-9/16	11.1-14.3	BSGB-075
5/8-11/16	15.9-17.5	BSGB-100
3/4-1	19.1-25.4	BSGB-125

These brushes are used for removing soft and light scale deposits in straight, ferrous and non-ferrous tubes. The abrasive impregnated nylon bristles of this brush clean and polish tubes in one step. Unlike regular spiral brushes Spingrit is designed to be oversized in the tube so the bristles lay over, putting the tube so the bristles lay over putting the abrasive in contact with the tube wall. Order brush to correspond with tube I. D.

POWER SPIN-GRIT BRUSHES

These brush are used for removing soft and light scale deposits in straight, ferrous and non-ferrous internally enhanced tubes. The small diameter end of each of each brush cleans into the grooves of the tube's rifling with the ends of the brush filaments. The large diameter end of the brush cleans the lands of the tube's rifling, as well as any prime surface, with the sides of the brush filaments. Order brush to correspond to tube I.D.



Tube I.D.		Power Spin-Grit Brushes
INCH	MM	
1/2	12.7	BPSGB-050
5/8	15.9	BPSGB-062
3/4	19.1	BPSGB-075
1	25.4	BPSGB-100

COLOR CODED SHOOT THRU SCRUBBERS

In most cases Hard Tube Scrubbers are recommended for removing light to medium deposits in condensers order.



Tube Scrubbers by Model & Color

Tube I.D.		Scrubber O.D. (INCH)	Model	Color	Type
INCH	MM				
0.495-0.541	12.57-13.74	0.560	BTS-560-S	Yellow	Soft
0.527-0.555	13.39-14.10	0.560	BTS-560	Yellow	Hard
0.570-0.620	14.50-15.75	0.630	BTS-630-S	Brown	Soft
0.590-0.630	15.00-16.00	0.630	BTS-630	Brown	Hard
0.620-0.675	15.75-17.15	0.695	BTS-695-S	Red	Soft
0.652-0.694	16.56-17.63	0.695	BTS-695	Red	Hard
0.660-0.730	16.76-18.54	0.750	BTS-750-S	Purple	Soft
0.710-0.750	18.03-19.05	0.750	BTS-750	Purple	Hard
0.730-0.800	18.54-20.32	0.825	BTS-825-S	White	Soft
0.777-0.819	19.74-20.80	0.825	BTS-825	White	Hard
0.780-0.850	19.81-21.60	0.870	BTS-870-S	Green	Soft
0.825-0.870	20.96-22.10	0.870	BTS-870	Green	Hard
0.870-0.944	22.10-24.00	0.960	BTS-960-S	Blue	Soft
0.886-0.950	22.50-24.13	0.960	BTS-960-M	Blue	Medium
0.902-0.956	22.91-24.28	0.960	BTS-960	Blue	Hard
1.000-1.085	25.40-27.56	1.100	BTS-1100-S	Black	Soft
1.027-1.106	26.09-28.09	1.100	BTS-1100	Black	Hard

CARBIDE DRILL for Plugged Tubes/Pipes

CARBIDE DRILL are used for cleaning straight tubes plugged solidly with deposits.



Carbide Drill

Tube I.D.		Carbide Drill
INCH	MM	
1/4	6.4	BCB-025
3/8	9.5	BCB-037
7/16	11.1	BCB-043
1/2	12.7	BCB-050
9/16	14.3	BCB-056
5/8	15.9	BCB-062
11/16	17.5	BCB-068

Note : All drill run 10% oversize {e.g. CB-062 drill is .6875" (17.5mm) O.D.}

FLEX-HONE ABRASIVE TOOLS

Tube I.D.		Flex-Hone Abrasive Tools
INCH	MM	
1/4	6.4	BFHT-025
5/16	7.9	BFHT-031
3/8	9.5	BFHT-037
7/16	11.1	BFHT-043
1/2	12.7	BFHT-050
9/16	14.3	BFHT-056
5/8	15.9	BFHT-062
11/16	17.5	BFHT-068
3/4	19.1	BFHT-075
7/8	22.2	BFHT-087
1	25.4	BFHT-100

FLEX-HOSE ABRASIVE TOOLS are light pressure, soft application honing devices for straight tubes. They consist of 180 grit silicon carbide abrasive globules (stones) bonded to high density nylon filaments. They are flexible, self-compensating for wear. Their unbreakable stones are formulated to provide for a long lasting, consistent finish. Order tool to correspond to tube I.D.

Note : Flex-Hone Abrasive Tools are normally used with a water flush for maximum life.



Flex-Hose Abrasive Tools

OL

These tools have either a cup brush, wheel brush or grinding tip attached to a 20"(508.0mm) piece of flexible shaft. They are designed to the bends of a U-tub from each side to clean the U-portion from both sides.

Tube I.D.		Cup Brush Tools
INCH	MM	
1/2-3/4	12.7-19.1	BCS-075B
1/2-3/4	12.7-19.1	BCS-075S



Cup Brush Tool

Tube I.D.		Wheel Brush Tools
INCH	MM	
1/2-3/4	12.7-19.1	BCW-075B
13/16-1	20.6-25.4	BCW-100B
1/2-3/4	12.7-19.1	BCW-075S
13/16-1	20.6-25.4	BCW-100S



Wheel Brush Tool

Note: U-Tube tool is also available with cobalt Grinding Tip.

BRUSHES

NYLON BRUSHES Recommended for removing soft deposits (Mud, algae. etc.) In straight, non-ferrous tubes. (Copper, Brass, Plastic, etc.) Order brush to correspond to tube I.D.



Nylon Brush

BRASS BRUSHES Recommended for removing soft and light scale deposits In straight, non-ferrous tubes. Order brush to correspond to tube I.D.



Brass Brush

STAINLESS STEEL BRUSHES Recommended for removing soft and light scale deposits. In straight, non-ferrous tubes. (Carbon steel, stainless steel, etc.) Order brush to correspond to tube I.D.



Stainless Steel Brush

Brush O.D.		Nylon Brush	Brass Brush	Stainless Steel
INCH	MM			
1.1/4	31.7	SSB-N-012	SSB-B-012	SSB-S-012
1.1/2	38.1	SSB-N-015	SSB-B-015	SSB-S-015
1.3/4	44.5	SSB-N-017	SSB-B-017	SSB-S-017
2	51.0	SSB-N-020	SSB-B-020	SSB-S-020
2.1/4	57.1	SSB-N-022	SSB-B-022	SSB-S-022
2.1/2	63.5	SSB-N-025	SSB-B-025	SSB-S-025
2.3/4	70.0	SSB-N-027	SSB-B-027	SSB-S-027
3	76.2	SSB-N-030	SSB-B-030	SSB-S-030
3.1/4	82.6	SSB-N-032	SSB-B-032	SSB-S-032
3.1/2	89.0	SSB-N-035	SSB-B-035	SSB-S-035
3.3/4	95.2	SSB-N-037	SSB-B-037	SSB-S-037
4	101.6	SSB-N-040	SSB-B-040	SSB-S-040

CLEANING ACCESSORIES



Brush O.D.		Carbon Brush	Plastic Brush
INCH	MM		
5	127.0	CS - 050	P - 050
6	152.4	CS - 060	P - 060
7	178.0	CS - 070	P - 070
8	203.2	CS - 080	P - 080
9	228.6	CS - 090	P - 090
10	254.0	CS - 100	P - 100
11	279.4	CS - 110	P - 110
12	305.0	CS - 120	P - 120
13	330.2	CS - 130	P - 130
14	355.6	CS - 140	P - 140

CARBON STEEL BRUSHES

Recommended for removing soft and light scale deposits in straight, ferrous tubes. Order brush to correspond to tube I.D.



Carbon Steel Brush

PLASTIC BRUSHES

Recommended for removing soft and light scale deposits in straight, ferrous tubes. Order brush to correspond to tube I.D.



Plastic Brush

POWER SPIN-GRIT BRUSHES

Recommended for removing soft and light deposits in straight, ferrous and non-ferrous internally enhanced tubes. The small diameter end of each brush cleans into the grooves of the tube' rifling with the ends of the brush filaments. The large diameter end of the brush cleans the lands of the tube's rifling, as well as any prime surfaces, with the sides of the brush filaments. Order brush to correspond to the I.D.



Power Spin-Grit Brush

PSGB-100 Power Spin-Grit Single Spiral Brush for tubes 1" (25.4mm) I.D.

PSGB-125 Power Spin-Grit Single Spiral Brush for tubes 1.1/4" (31.7mm) I.D.

Note : Brushes over 1" O.D. Require # TCB-C Coupling to connect to NFSC-705, & NFSC-706 Shafts (over couplings supplied with brush order.)

WHEEL BRUSH ASSEMBLIES : To order Wheel Brush Assemblies refer to the table below listing the types of tubes to be cleaned straight or curved.

STRAIGHT TUBE WHEEL BRUSH ASSEMBLIES

Recommended for removing soft and light scale deposits (rust, soot, algae, etc.) In straight tubes. Each assembly consists of four stainless steel wire wheel brushes attached to a universal joint. Brushes should be 1/8" - 1/4" (3.2-6.4mm) smaller than tube I.D. Replacement brush elements are available as shown in table below.



Curved Tube I.D.		Wheel Brush Assembly	Actual Brush O.D.		Replacement Brushes (2 req.)	Replacement Universal Joint	Replacement Retainer Bolt
INCH	MM		INCH	MM			
1.1/8-1.1/4	28.6-31.7	WBS-100	1	25.4	WBR-100	CUJ-001	SWB-001
1.3/8-1.1/2	36.0-38.1	WBS-125	1.1/4	31.7	WBR-125	CUJ-001	SWB-001
1.5/8-1.3/4	41.3-44.5	WBS-150	1.1/2	38.1	WBR-150	CUJ-001	SWB-001
1.7/8-2	47.6-51.0	WBS-175	1.3/4	44.5	WBR-175	CUJ-002	SWB-002
2.1/8-2.1/4	54.0-57.1	WBS-200	2	51.0	WBR-200	CUJ-002	SWB-002
2.3/8-2.1/2	60.3-63.5	WBS-225	2.1/4	57.1	WBR-225	CUJ-002	SWB-002
2.5/8-2.3/4	66.7-70.0	WBS-250	2.1/2	63.5	WBR-250	CUJ-002	SWB-002
2.7/8-3	73.0-76.2	WBS-275	2.3/4	70.0	WBR-275	CUJ-002	SWB-002
3.1/8-3.1/4	79.4-82.6	WBS-300	3	76.2	WBR-300	CUJ-002	SWB-002

Note : For larger sizes consult factory.

CURVED TUBE WHEEL BRUSH ASSEMBLIES

Recommended for removing soft and light scale deposits (rust, soot, algae, etc.) In straight tubes. Each assembly consists of four stainless steel wire wheel brushes attached to a universal joint. Brushes should be 1/8" - 1/4" (3.2-6.4mm) smaller than tube I.D. Replacement brush elements are available as shown in table below.



Curved Tube Wheel Brush Assembly

Curved Tube I.D.		Wheel Brush Assembly	Actual Brush O.D.		Replacement Brushes (two req.)	Replacement Universal Joint	Replacement Retainer Bolt
INCH	MM		INCH	MM			
1.1/4-1.3/8	31.7-35.0	WBC-100*	1	25.4	WBR-100	CUJ-003*	CWB-001
1.1/2-1.5/8	38.1-41.3	WBC-125*	1.1/4	31.7	WBR-125	CUJ-003*	CWB-001
1.3/4-1.7/8	44.5-47.6	WBC-150*	1.1/2	38.1	WBR-150	CUJ-003*	CWB-001
2-2.1/8	51.0-54.0	WBC-175	1.3/4	44.5	WBR-175	CUJ-002	CWB-002
2.1/4-2.3/8	57.1-60.3	WBC-200	2	51.0	WBR-200	CUJ-002	CWB-002
2.1/2-2.5/8	63.5-66.7	WBC-225	2.1/4	57.1	WBR-225	CUJ-002	CWB-002
2.3/4-2.7/8	70.0-73.0	WBC-250	2.1/2	63.5	WBR-250	CUJ-002	CWB-002
3-3.1/8	76.2-79.4	WBC-275	2.3/4	70.0	WBR-275	CUJ-002	CWB-002
3.1/4-3.1/2	82.6-89.0	WBC-300	3	76.2	WBR-300	CUJ-002	CWB-002

Note : For larger sizes consult factory.
 Note : BPTC-706 Coupling required to connect BPFs-720 and BPFs-721 & BPF-821 flexible shafts.

BUFFING TOOLS FOR Tubes/Pipes 1"-3" (25.4-76.2mm) I.D. Stainless Steel Wire Buffing Tool are used for light to medium scale deposits of for finishing tubes previously "roughed out" with other cleaning tools. They can be used in both ferrous and non-ferrous tubes. Buffing tool are normally used in straight tubes but will go through very large radius bends.



Buffing Tool



Replacement Blades



Buffing Tool with Drill Tip

BPTC-223 Adjustable Buffing Tools for tubes 1"-3" (25.4-76.2mm) I.D.
BPTC-223DT Adjustable Buffing Tools for tubes 1"-3" (25.4-76.2mm) with drill up.
BPTC-224 Replacement Blades for BPTC-223.

CARBIDE DRILLS For Plugged Tubes/Pipes Carbide Drills are used for cleaning straight tubes plugged solidly with scale or deposit.



Carbide Drill

Tube I.D.		Carbide Drill
INCH	MM	
3/4	19.1	BCB-075
7/8	22.2	BCB-088
1	25.4	BCB-100

Note: All drills run 10% oversize [e.g. CB-015 Drills is 0.825" (21.0mm) O.D.]

FLEX-HONE ABRASIVE TOOLS For Tubes/Pipes 1.1/4" (31.7mm) I.D. and UP Flex-Hone Abrasive Tool are light pressure, soft application honing devices for straight tubes. They consist of 180 grit silicon carbide abrasive globules (stones) bonded to high density nylon filaments.

They are flexible, self-centering, self-aligning and self compensating for wear. Their unbreakable stones are formulated to provide for a long lasting, consistent finish. Order tool to correspond to tube I.D.



Flex-Hone Abrasive Tool

Tube I.D.		Flex-Hone Abrasive Tools
INCH	MM	
1.1/4	31.7	FHT-125
1.1/2	38.1	FHT-150
1.3/4	44.5	FHT-175
2	51.0	FHT-200
2.1/4	57.1	FHT-225
2.1/2	63.5	FHT-250
2.3/4	70.0	FHT-275
3	76.2	FHT-300

Note : For larger sizes consult factory. Flex-Hone Abrasive Tools are used with water flush for maximum life

CONE CUTTER ASSEMBLIES Cone Cutter Assemblies are used for removing scale from curved and straight tubes. Assemblies are slightly smaller than tube I.D. Scale is cut at the smaller tapered end finished at the larger end. The rotation of the tool ensures a through cleaning. In water tube boiler, cone cutters are the most effective cleaning tools for all conditions. To order refer to the tables below.

SINGLE AND DOUBLE CONE ASSEMBLIES

Assemblies consisting of one or two cone elements are used for cleaning straight tubes 1.1/8"-2.5/16" (28.6-58.7mm) I.D. And curved tubes 11/4" - 2.3/8" (31.7-60.3mm) I.D.

Straight Tube I.D.		Curved Tube I.D.		Complete Single Cone Assembly	Complete Double Cone Assembly	Cone Max		Replacement Cone Only	Universal Joint	Single Cone Bolt	Double Cone Bolt
INCH	MM	INCH	MM			INCH	MM				
1.1/8-1.1/4	28.6-31.7	1.1/4-1.3/8	31.7-35.0	BSCA-100	BDCA-100	1	25.4	RCO-100	CUJ-001	CRB-001	DCB-001
1.5/16-1.3/8	33.3-35.0	1.1/2-1.5/8	38.1-41.3	BSCA-112	BDCA-112	1.1/8	28.6	RCO-112	CUJ-002	CRB-002	DCB-002
1.7/16-1.1/2	36.5-38.1	1.3/4-1.7/8	44.5-47.6	BSCA-125	BDCA-125	1.1/4	31.7	RCO-125	CUJ-002	CRB-002	DCB-002
1.9/16-1.3/4	39.7-44.5	2-2.1/8	51.0-54.0	BSCA-150	BDCA-150	1.1/2	38.1	RCO-150	CUJ-002	CRB-002	DCB-002
1.13/16-2	46.0-51.0	2.1/4-2.3/8	57.1-60.3	BSCA-175	BDCA-175	1.3/4	44.5	RCO-175	CUJ-002	CRB-002	DCB-002
2.1/16-2.5/16	52.4-58.7			BSCA-200	BDCA-200	2	51.0	RCO-200	CUJ-002	CRB-002	DCB-002



Replacement Cone



Single Cone Assembly



Double Cone Assembly



Disc Cone Assembly

DISC CONE ASSEMBLIES Assemblies consisting of three cones are used for cleaning straight tubes 2.3/8-3.3/4"(60.3-95.2mm) I.D. and curved tubes 2.1/2-4" (63.5-101.6mm) I.D.

Straight Tube I.D.		Curved Tube I.D.		Complete Disc Cone Assembly	Replacement Cone Only (three req.)	Disc Only (less cones)	Universal Joint	Cone Retainer Bolt (three req.)
INCH	MM	INCH	MM					
2.3/8-2.13/16	60.3-71.4	2.1/2-3.1/16	63.5-77.8	BDC-101	PCO-100	PCD-101	CUJ-002	CRB-001
2.7/8-3.5/16	73.0-84.1	3.1/8-3.5/8	79.4-92.1	BDC-102	PCO-100	PCD-102	CUJ-002	CRB-001
3.3/8-3.3/4	85.7-95.2	3.11/16-4	93.7-101.6	BDC-103	PCO-112	PCD-102	CUJ-002	CRB-002

FLEX HUB TOOLS Flex Hub Tools use centrifugal force activated blades for removing hard and heavy deposits in straight or curved tubes. A drill can be attached to the front of the BPTC-227 or BPTC-231 Flex Hub to severely clogged tubes.

Straight Tube I.D.		Curved Tube I.D.		Flex Hub Assembly
INCH	MM	INCH	MM	
7/8-11/2	22.2-38.1	1-1.3/4	25.4-44.5	BPTC-226
1.1/2-2	38.1-51.0	1.3/4-2.1/2	44.5-63.5	BPTC-231
1.3/4-3	44.5-76.2	2.1/2-3	63.5-76.2	BPTC-227



Flex Hub Assembly



Replacement Blades



Universal Joint



Carbide Drill

BPTC-223 Replacement Blades for BPTC-226 (set of three).

BPTC-231A Replacement Blades for BPTC-231 (set of three).

BPTC-227A Replacement Blades for BPTC-227 (set of three).

CB-088 Drill to be attached to **BPTC-227** Flex Hub Assembly for use when tubes are severely clogged.

CB-075 Universal Joint for use with above Flex Hub Assembly for use when tubes are severely clogged.

CUJ-002 Universal Joint for use with above Flex Hub Assemblies when minimum tube bend radius is less than 5xtube I.S. (Consult factory)

DRILL CONE ASSEMBLIES For Plugged Tubes/Pipes 1"-1.7/8" (25.4-47.6mm)I.D.

Drill/Cone Assemblies are recommended for cleaning straight tubes plugged solidly with deposits. Order assembly to corresponded to tube I.D. All drill run 10% oversize.

Tube I.D.		Drill Cone Assembly
INCH	MM	
1	25.4	DC-100
1.1/8	28.6	DC-112
1.1/4-1.3/8	31.7-35.0	DC-125
1.1/2-1.5/8	38.1-41.3	DC-150
1.3/4-1.7/8	44.5-47.6	DC-175



Drill/Cone Assembly

ROTATING CUTTING WHEEL TOOLS For Tubes/Pipes 1.1/2"-3.15/16" (38.1-100.0mm) I.D. Rotating Cutting Wheel Tools incorporate self-centering, centrifugally activated serrated cutting wheels for removing light to heavy deposits in straights or curved tubes, typically in boilers.

Tube I.D.		Cutting Wheel Tools
INCH	MM	
1.1/2-1.13/16	38.1-46.0	BRCW-150
1.7/8-2.3/16	47.6-55.6	BRCW-187
2.1/4-3.1/8	57.1-79.4	BRCW-225
3.3/16-3.15/16	81.0-100.0	BRCW-312



Rotating Cutting Wheel Tools

CW-062 Replacement Cutting Wheel for BRCW-150 OR BRTC-187.

CW-093 Replacement Cutting Wheel for BRCW-225 OR BRTC-312.

FLARE CONE TOOLS For Tubes/Pipes 1.3/4"-6.1/2" (44.5-165.1mm)I.D. (Rigid Arm)

Rigid Arm Flare Cone Tools incorporate centrifugal force activated, cones for removing light to heavy deposits in straight tubes.



Rigid Arm Flare Cone Tool

Tube I.D.		Flare Cone Tools
INCH	MM	
1.3/4-4	44.5-101.6	BFCT-300
4-6.1/2	101.6-165.1	BFCT-301



Flexible Arm Flare Cone Tool

BRCO-100 Replacement Cone (three required).

BCRB-001 Replacement Cone Retainer Bolt (three required).

For Tubes/Pipes 4"-12 (101.6-305.0mm) I.D. (**Flexible Arm**)

The Flexible Arm Flare Cone Tool incorporates centrifugal force activated cones for removing light to heavy scale deposits in straight or curved tubes. Use typically in vertical tubes.

BFCT-600 Flexible flare Cone Tool 4"-12 (101.6-305.0mm)I.D.

BRCO-001 Replacement Cone (six required).

BCRB-001 Replacement Cone Retainer Bolt (six required).

FLARE BRUSHES For Tubes/Pipes 1"-8" (25.4-203.2mm) I.D. Flare Brushes incorporated centrifugal force activated wire cobalt tips for light descaling and polishing of straight or curved tubes.

Tube I.D.		Flare Brushes
INCH	MM	
1-2	25.4-51.0	BFBT-301
2-4	51.0-101.6	BFBT-501
4-8	101.6-203.2	BFBT-502



Three Strand Flare Brush Five Strand Flare Brush

NOTE : We also manufacture Universal Nylon Rod Tool.

HIGH PRESSURE WATER JET CLEANING MACHINE AND PUMP

SHINGARE INDUSTRIES PVT. LTD. is specialized in Designing, Manufacturing, Marketing and Servicing of High Pressure Pump for various applications in all industrial segments.

The Pumps are designed and manufactured indigenously under strict quality control and also supported by a prompt after sales services. The Pump units are complete with Prime Mover (Electric Motor / Diesel or Gas Engine), Speed Reduces (Pulley drive / Gear Box), Control Panel, Standard accessories like relief valve, pressure gauge and regulating valves. Mountings either on Base plate Oil field Skid, or Trailers depending on customer requirements.

WATER JETTING MACHINE

COMPACT

High Pressure water jet machine, are used for hundreds of various cleaning applications in almost all types of industries around the world. Our High Pressure cleaners are designed & manufactured with latest European technologies with superior quality materials.



Compact Model No.	Maximum Pressure (BAR/PSI)	Water Flow Rate (LPM)	Motor Power HP	Power
C-12010	120/1740	10	3	Single Phase
C-13010	130/1885	10	5	Single Phase
C-10015	100/1450	15	5	Three Phase
C-15030	100/1450	30	5	Three Phase
C-15015	150/2175	15	5	Three Phase
C-20021	200/2900	21	21	Three Phase
C-25021	250/3625	21	21	Three Phase
C-35021	350/5075	21	21	Three Phase
C-400/15	400/5800	15	15	Three Phase

HIGH PRESSURE WATER JETTING MACHINE

450 TO 1400 BAR

high-pressure water jetting machines are used for Heat Exchanger, Condenser, Evaporator, Calendria, Boiler etc. in various industries like textile, pharmaceutical, steel, chemical, refineries and many more.



MODEL NO.	MAXIMUM PRESSURE (BAR/PSI)	WATER FLOW RATE (LPM)	MOTOR POWER (HP)	POWER
BHP-40015E	400/5800	15	15	3 Phase
BHP/50030E	500/7250	30	40	3 Phase
BHP/60045E	600/8700	45	60	3 Phase
BHP/75035E	750/10875	35	60	3 Phase
BHP/100040E	1000/14503	40	100	3 Phase
BHP/110052E	1100/15955	52	150	3 Phase
BHP/120053E	1200/17405	52	200	3 Phase

ACCESSORIES:

High Pressure Hose:

Specially designed to withstand high pressures, Swivel connector for easy connection. To connect pump delivery line to Foot Operated Valve.



Pressure Regulating Valve:

Regulate output pressure as required bypass excess water.



Safety Valve:

Intentionally designed weak part to avoid major loss provide over pressure protection



Nozzle(Straight,Forward,Backward Firing Nozzels)

Highly effective and time saving than conventional. For surface cleaning, cutting and general applications. Backward firing nozzle mainly used For effective cleaning of tubes.



Flexible Lance:

To connect Foot Operated Valve to Nozzle specially designed to withstand high pressures.small diameter pipes to easily enter inside ID of tubes.



Floot Valve:

To start-stop and control water flow through foot of operator, while keeping his hands free for the in-out movement of flexible lance inside tubes. Its necessary for Operator safety to avoid any accident.



Rigid Lance:

Made up of SS material, For easy & firm grip to counter the back pressure at the time of in & out of nozzle.



To view demo of above machine please visit our below youtube link <https://youtu.be/g7TbkXPQZ5k>
(If you cannot click below then either copy and paste the same in the browser or scan below QR code)



HOT & COLD WATER JETTING MACHINE



High pressure water jet machine uses to remove oil, mold, grime, dust, mud and dirt from surfaces and objects such as buildings, vehicles and concrete road surfaces.

ESTILO MODEL NO.	ES - 12010	ES - 15015	ES - 20015
Pressure	120 bar	150 bar	200 ba
Flow Rate	10 LPM	15 LPM	15 LPM900 l/h
Max Water Temp.	0-130°C	0-130°C	0-130°C
Motor Revolution	1450 RPM	1450 RPM	1450 RPM
Power Supply	230V - 50 Hz	400V - 50 Hz	400V - 50 Hz
Motor Power	3 HP	5,5 HP	7,5 HP
Dimensions mm	880 x 590 x 730	880 x 590 x 730	880 x 590 x 730
Diesel Tank Capacity	14 IT	14 IT	14 IT
Weight	114 Kg	118 Kg	125 Kg



FEATURES:

- Stainless Steel Boiler
- Triplex pump with ceramic plungers, connecting rod system
- Brass pump head
- Automatic by-pass valve
- Pressure gauge
- Built-in detergent suction
- Boiler shut-down delayed circuit
- With safety pressure switch to shutdown the boiler in case of lack of water
- Induction Three Phase motor with thermal protector
- Thermostat

- Detergent tank 4/5L
- Vertical stainless steel boiler cooling function driven by independent electric motor, double heating coil with refractory cement base.
- 5m Electric cable
- Diesel tank 15L, with discharge plug
- Water and diesel filters
- TSS, remote control for shutdown of high pressure cleaner
- Adjust high/low pressure and fan/pencil jet spray head
- Accessories Holder

ACCESSORIES:

Suction Hose:

Are available for all discharge capacities in standard lengths. They are either nylon type or wire braided type.



Delivery Hose:

Available in standard lengths with hydraulic high pressure BSP connections for working pressures from 2,000 PSI to 20,000PSI.



ON/OFF Gun Rigid Lance and Nozzles:

These are the portable guns used for light duty small high pressure portable cleaners, manually controlled by use of trigger.



BOILER TUBE EXPANDER



'BA' SERIES (3 PLAIN ROLLERS)



(PARALLEL TYPE TUBE EXPANDER)
 Sizes Available : 7/8" O.D. to 4½" O.D.
 Models Available : BA-31 to BA-102

FEATURES:
 Time tested, durable design. Sturdy construction with rolls self contained in cage. Best 'Value for Money' tool in the world when parallel rolling tubes.

'B114' SERIES



(4 Plain Rollers & 2 Flare Rollers)
 Sizes Available : 2" O.D. to 4½" O.D.

FEATURES:
 Overlapping rolls prevent ridging of tube. Can be converted for parallel expansion use enquire with us. Self retained rolls in cage.
Use: General purpose expander for expanding and flaring boiler tubes, water wall, downcomer, economizer, riser, & air heater tubes.

LONG REACH 'BCSB' SERIES

(Parallel Type- 5 Plain rollers)



FEATURES:
 '5-Roll' Design is used primarily for rolling thin walled tubes used in sugar mill pan, juice heaters etc. '5-Roll' gives a more concentric, uniform expansion vs a 3 roll expander in thin tubes & reduces spring back action. Time tested, durable design.
 Use - For **BOTTOM** plate tube expansion in pan, juice heaters in sugar mills.

('BCSB' TUBE EXPANDER WITH 5-Plain rollers)

Sizes Available : 1.1/2" O.D. to 4½" O.D.
 Models Available : BCSB-5 TO BCSB-24.

'BAF3' SERIES (3 PLAIN ROLLERS, 3 FLARE ROLLERS)



(FLARE TYPE TUBE EXPANDER)
 Sizes Available : 7/8" O.D. to 4½" O.D.
 Models Available : BA-31 to BA-102

FEATURES:
 Time tested, durable design. Sturdy construction with rolls self contained in cage. Best 'Value for Money' tool in the world when parallel rolling tubes.
 Use - Economical tool used for applications where tubes are to be expanded with flaring.

'BSB' SERIES



(TUBE EXPANDER WITH 5-Plain rollers)
 Sizes Available : 1.1/2" O.D. to 4½" O.D.
 Models Available : BSB-00A TO BSB-27C

FEATURES:
 'BSB' SERIES (Parallel Type- 5 Plain rollers)
 '5-Roll' Design is used primarily for rolling thin walled tubes used in sugar mill pan, juice heaters etc.
 '5-Roll' gives a more concentric, uniform expansion vs a 3 roll expander in thin tubes & reduces spring back action.
 Time tested, durable design.
Use: For **TOP** Plate Tube Expansion in Pan, Juice heaters.

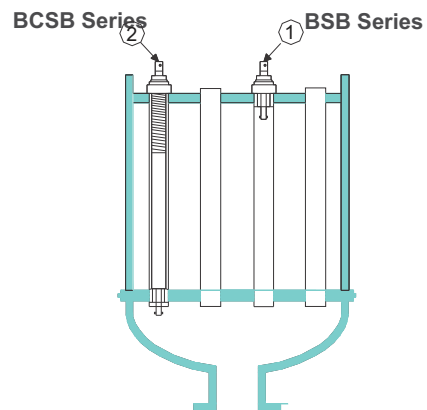

NOTE: We also manufacture other series of tube expander such as BAB, BABF3, B-1000, B-3000, combination beading Type tube expander. We can also design & manufacture tube expander for tube OD up to 250mm (10") or more.

CONDENSER TUBE EXPANDER



'B900' SERIES



Sizes Available : 1/4" O.D. To 3/8" O.D.

Tube Internal diameter :

3.8mm (0.152") to 8.4mm (0.331")

Roller Length of Tube Expander :

3/4" (19.05mm) & 1.1/4" (31.75mm)

FEATURES:

This tool has been the work horse for several years for use on small diameter tubes.

Use - Oil coolers, Radiators, & other apparatus with small.

'B800' SERIES



Sizes Available: 1/2" O.D. to 1.1/2" O.D.

Tube Internal diameter :

8.4mm (0.334") to 36.3mm (1.43")

Roller Length of Tube Expander:

1.1/2" (38.1mm) & 2.1/4" (57.1mm)

FEATURES:

Use -This is the most popular expander for use on heat exchangers and condensers with tubes of 1/2"- 1.1/2" O.D.

TUBE SHEET ADJUSTABLE RANGE:

FOR 1.1/2" ROLLER LENGTH: 1 1/2" to 1.1/2"

FOR 2.1/4" ROLLER LENGTH: 1.1/4" to 2.1/4"

'B8012' SERIES



Sizes Available : 1.3/4" O.D. to 8" O.D.

Tube Internal diameter :

36.1mm (1.420") to 190mm (7.48")

Roller Length of Tube Expander: 2.1/4" 57.1mm)

FEATURES:

Use -This is recommended to expand tubes in air heaters boilers , & refinery still tubes. Can be used to expand thick tube sheets (Upto 8")

TUBE SHEET ADJUSTABLE RANGE:

FOR 2.1/4" ROLLER LENGTH: 1 1/2" to 8"

'B1300' SERIES



Sizes Available : 3/8"

Tube Internal diameter :

5.8mm (0.231") to 8.4mm (0.331")

Roller Length of Tube Expander:

3/4" (19.05mm) & 1.1/4" (31.75mm)

FEATURES:

Use - Oil coolers, Radiators, & other apparatus with small diameters tubes & thick tube sheets.

NOTE: All 'B1300' series expanders come with 1/4" square mandrel drives. Round mandrel drives are optional.

'B1200' SERIES LONG REACH



Sizes Available: 1/2" O.D. to 1.1/2" O.D.

Tube Internal diameter :

8.4mm (0.334") to 36.3mm (1.43")

Roller Length of Tube Expander:

1.1/2" (38.1mm) & 2.1/4" (57.1mm)

FEATURES:

Use -This is recommended for heat exchanger & condenser with tubes of 5/8"- 1.1/2" O.D. & thick tube sheets.

TUBE SHEET ADJUSTABLE RANGE:

FOR 1.1/2" ROLLER LENGTH: 1.1 1/2" to 12"

FOR 2.1/4" ROLLER LENGTH: 2.1/4" to 12.3/4"

VERNAN TUBE EXPANDER



BS-SERIES



BA-SERIES

Sizes Available : a.1/2"- 2" O.D.

Tube Internal diameter :

8.22mm (0.324") to 50.8mm (2")

FEATURES:

Use -This is recommended to expand Stainless Steel thick tubes in heat exchanger having tube sheet up to 2.1/2"(63.5mm)

TUBE SHEET ADJUSTABLE RANGE:

FOR 2.1/4" ROLLER LENGTH: 1 1/2" to 8".

TORQUE CONTROLLED TUBE EXPANSION SYSTEM: (Wattage Based)

1. Fully Solid State Design - no moving parts - no wear and tear - no noise - consequently long life.
2. Uses the latest micro-controller chip for control functions.
3. Uses one main circuit board for easy maintenance.
4. Accurately calibrated digital torque setting with a resolution of 1 watt makes torque settings accurate and can be easily reproduced for identical results.
5. Connected drive is automatically recognized & indicated by means of LED on the torque controller.
6. Soft start has been provided for all drives, which reduces starting currents in the drive. As a result, life of Carbon brushes & drive increases.



Model No.	Voltage Single Phase 50/60 Hz	Weight (KG)
TCW-09-110	110 V	11.0
TCW-09-230	230 V	11.0

Note :

Use Voltage Stabilizers with TCW torque controllers. All TCW torque controllers are supplied with operation manuals.

ELECTRIC TUBE EXPANSION SYSTEM:

Electrically Operated Drive Units For Wattage Based Tube Expansion Machine

FEATURES:



1. It consists of heavy duty German Made motors.
2. Continuous cycle operation vs. Intermittent cycle operation of drives from other manufactures.
3. High torque to weight ratio.

DRIVE MODEL		NO LOAD SPEED R.P.M.	EXPANSION RANGE		FULL LOAD CURRENT APMS		DRIVE WEIGHT KGS.
230V	110V		S. STEEL TUBE O.D.	COPPER TUBE O.D.	230V	110V	
MPG-0N	MPG-0L	2800	6 to 10	6 to 12	2.6	2.6	2.0
MPG-1N-I	MPG-1L-I	1000	10 to 16	13 to 20	6.0	6.0	2.5
MPG-1N-II	MPG-1L-II	1900	8 to 13	11 to 16			
MPG-2N-I	MPG-2L-I	480	16 to 45	16 to 50	12.0	12.0	7.5
MPG-2N-II	MPG-2L-II	1080	16 to 32	16 to 38			
MPG-3N-I	MPG-3L-I	130	25 to 76	25 to 102	12.0	12.0	8.5
MPG-3N-II	MPG-3L-II	430	25 to 50	25 to 76			

VOLTAGE STABILIZER / TRANSFORMERS:

FEATURES:

- * Digital display of output voltage.
- * Used in on site application and areas which has high voltage fluctuations.

Note : We also supply current based Electric Tube Expansion system. Any query, please contact us.

To view demo of above machine please visit our below youtube link <https://youtu.be/d4bKdteXgzY>
(If you cannot click below then either copy and paste the same in the browser or scan below QR code)



HYDRAULIC TUBE EXPANSION SYSTEM

FEATURES:

1. Drive communicates with the pump via 9v DC remote control. This ensures safety & Eliminates the need of electrical
2. Compatibility- Same power pack for all 4 drives to expand 5/8" OD to 4" OD tube.
3. Very high Torque developed- can expand large diameter, thick wall tubes in thick tube sheets easily.
4. Boiler erections get completed in record time.
5. Can be use for long working hours because drive is unaffected by heat.
6. Dual drive power pack is available to connect 2 drives to single power pack to cut down tube expansion time by further 50%.
7. Microprocessor controls on the pump automate the expansion cycle. Trip, pause & reverse times For the drive are adjustable. No need for repeated manual STOP/ START of the drive during Expansion cycle- Complete automatic. The hydraulic pump supplied with hydraulic drive incorporates the latest state of the technology resulting in a subcompact pump developing 100 bar pressure. The system is mounted on four wheels for on site manoeuverability. Expansion of tubes is regulated by adjusting pressure setting pump. Once required amount of wall thinning is achieved the drive trips automatically.



HYDRAULIC PUMP BHEP-500

	Hydraulic Pump Model		
	BHEP-300	BHEP-500	BHEP-1000
Oil tank capacity (Litres)	30	80	138
Hydraulic Oil	SAE VG 68	SAE VG 68	SAE VG 68
Net Weight (Kgs)	80	100	220
Maximum Working Pressure (bar)	100	100	100
Electrical Motors	3 hp., Single phase	5 hp., Three phase	10hp., Three phase
Voltage	230v / 110v	415V	415V
Overall Dimensions (mm)	610 x 270 x 985	820 x 470 x985	1775 x 550 x 1200
Standard Hose Size (Length)	1/2"(10 mtrs.)	1/2"(10 mtrs.)	1/2"(10 mtrs.)

HYDRAULIC DRIVES



Tube Expansion Range				Model No.	Square Socket INCH	Drive No Load Speed (RPM) With BHEP 300 / 500 / 1000	Drive Weight KGS.
Steel Tube O.D.		Copper Tube I.D.					
MM	INCH	MM	INCH				
15-25	5/8-1	25-38	1-1.1/2	BHED-3	3/8	620 / 954 / 800	9.6
19-38	3/4-1.1/2	32-64	1.1/4-2.5	BHED-4	3/8 & 1/2	350 / 480 / 400	9.7
38-76	1.1/2-3	50-102	2-4	BHED-5	1/2 & 3/4	62 / 84 / 70	11.0
50-102	2-4	-	-	BHED-6	3/4 & 1	40 / 62 / 54	11.5

NOTE: Above expansion system comes along with pair of hydraulic hoses, supply cables, remote control, & drive sockets of 1/2", 3/4" or 1" square.

Dual drive power pack is available to connect 2 drives to single power pack to cut down tube expansion time. By further 50%.

To view demo of above machine please visit our below youtube link <https://youtu.be/RqJPN2T4sPI>
(If you cannot click below then either copy and paste the same in the browser or scan below QR code)



SERRATING / GROOVING TOOL 'ST' SERIES



FOR GROOVING IN TUBE SHEETS

Sizes Available : 3/8" O.D. to 2.1/2" O.D.

FEATURES:

- High production tool.
- Ideal for use where 1 tool is needed per bore.
- One piece cryogenically treated tool bit ensures maximum life.
- Its suited for CNC application on account of 1 piece mandrel construction & short design.
- Note: Grooving tools are available for MM bore sizes also, Please enquire.

TUBE END FACER- 'BTEF' SERIES



Sizes Available : 3/8" O.D. To 4" O.D.

FEATURES:

- Tool bits are coated with Titanium Nitride to give 3 times the life of conventional tool bits.
- Ideal for quick facing of projecting tube ends in heat exchanger, condensers & boilers.
- One size of tool is suitable for use on multiple tube thickness by interchanging pilot. (TEF-375 is the exception with the tool suitable for one tube ID only.)
- Each tool is supplied with a set of multiple pilots to cover tube thickness.
- Tube end facers for MM sizes of tubes also available. Please Enquire.

TUBE SHEET HOLE REAMER



Sizes Available : 3/8" O.D. To 4" O.D.

FEATURES:

- Ideal for heat exchanger and condenser tube sheet reaming.
- High speed steel, cryogenically treated & coated with Titanium, Nitride for long life.
- Reamers are available in MM sizes also.
- For larger diameters, please enquire.

SERRATING / GROOVING TOOL 'NW' SERIES



Sizes Available : 3/8" O.D. To 2.1/2" O.D.

FEATURES:

- Simple to change cutter for different groove shapes.
- Changing of pilot nose & cutter allows one tool to cover a range of hole diameters.
- Location & depth of cut easy to adjust.
- Only light pressure required to cut precision grooves.
- Ready to fit CNC drill machines, lathe and boring machines.
- The life of the cutter extendable by re-shapening.

TUBE END FACER- 'BFC' SERIES / WELD REMOVAL TOOL



Sizes Available : 3/8" O.D. To 4" O.D.

FEATURES:

- Tool uses 3 cutting blades which can be configured for tube end facing or weld removal as step in the removal of welded tubes from the tube sheet.
- Tool fitted with MT shank for use with standard air or electric drills.
- Cutting blades are titanium Nitride coated to give 3 times the life Of conventional cutting blades.
- Ideally suited for work on larger diameter boiler tubes .
- Tools available for MM sizes of tubes also. Please enquire

OUR OTHER TUBE INSTALLATION TOOLS ARE

- SERRATING / GROOVING TOOL 'SGT' SERIES
- TUBE END FACER- 'BFB' SERIES
- FLARING TOOL
- BEADING TOOL
- BELLING TOOL
- TUBE SHEET HOLE RADIUS CUTTER
- TUBE GUIDE

TUBE REMOVAL TOOLS & MACHINES



PUSH TYPE INTERNAL TUBE CUTTER- BAP SERIES



Sizes Available : 5/8" O.D. To 1.1/2" O.D.

FEATURES:

- BHARTIYA "Push Type" internal tube cutter quickly cuts through the walls of ferrous tubes in condensers and Heat exchanger as step in their Removal from the tube sheet.
- This sturdy "Push Type" internal tube cutters can be used with a portable Electric or Air Drill Motor.
- "Push Type" cutter is simple to operate. Merely insert it into the tube. Apply power press inward and the tube can be cut in few seconds. Releasing of inward pressure automatically retracts the Cutter Bit. This cutter is equipped with an adjustable collar suitable for reaching into tubes at various depths.
- The replaceable cutting bit can be interchanged in a few seconds. Standard adjustable reach is 4" (101.6mm) and they are available In optional

MANUAL TUBE PULLER



Sizes Available : 1/4" O.D. To 1" O.D.

FEATURES:

- Simple Design: Only two major parts reduce inventory.
- No power needed: Manual insertion and removal of tube with a hand wrench. Ideal for field service application.
- Ease of use: Hex at back of spear allows tightening without disassembly of thrust mechanism.
- Range of Sizes: A wide range of sizes allows use on popular tube size. Clarity of marking: Both spear & thrust collar are clarify Marked for last relating tool to job.
- Larger sizes can be mad e available on request.

TUBE DRIFT/KNOCK OUT TOOL



Sizes Available : 3/8" O.D. To 4" O.D.

FEATURES:

- The drifts are available for mm tube sizes also. Please enquire.
- It is used with pneumatic chipping hammer to knock out. Tubes/ tube stubs form tube sheet
- Available in 01 & 06 shanks as standard. 15 (Jumbo) shank available on request.
- Standard reach is 6" Longer reaches are available.

COLLAPSING TOOL



Sizes Available : 3/8" O.D. To 2.1/2" O.D.

FEATURES:

- It is used to collapse tube and drive out collapsed tube from tube sheet with a chipping hammer.
- It is used with pneumatic chipping hammer to knock out Tubes/ tube stubs form tube sheet.
- Available in 01 & 06 shanks as standard.
- Collapsing tools are available for mm tube size and large tube Sizes. Please enquire.

OUR OTHER TUBE REMOVAL TOOLS ARE

INTERNAL TUBE CUTTER-BPR-68 | ONE REVOLUTION INTERNAL CUTTER- BOTC SEROSE | TUBE PLUGS | 'PINE JENNY' STYEL TUBE PULLING ACCESSORIES | TUBE WALL REDUCER.

FEATURES

- Compact and lightweight gun and powerpack.
- Simple and robust operation.
- High pressure pump for stub pulling toughest jobs.
- Breaks tube joint without damage.
- Low set up time / ease of operation
- Automatic switch over from low pressure to high pressure.
- Interchangeable pulling gun accessories compatible with existing systems on the market.
- Single man operation.



STPP-300

TUBE PULLING POWERPACK - SPECIFICATIONS

Model	Volts / Phase	Power	Oil Tank Capacity	Net Wt.	Dimension	Hyd. Hoses Size x Length
		HP/KW	LTRS.	KGS.	MM	INCH x MTRS.
STPP - 300	230/1	2.25/1.5	10	68	510 x 370 x 680	1/4"x 5 Twin Jack Hose
STPP - 300 (Pneumatic)	-	-	10	65	510 x 370 x 680	1/4"x 5 Twin Jack Hose

Note:Max.Working Pressure 700 bar. All power pack supplied with 5 mtr. Long hydraulic hose

HYDRAULIC TUBE PULLING GUN - SPECIFICATIONS

Gun Model	Pulling Capacity Tons	Max. Tube O.D. Thru Gun INCH	Stub Pulling Capacity INCH	Weight		Free Pulling Speed (Meter / Min) with STPP-300
				KGS.	LBS.	
SHPG-15	15	1	1.1/2	18	40	3.3
SHPG-30	30	1.1/2	3	25	55	2.0
SHPG-45	45	3	4	51	112	1.3



SPRING BALANCER

- Used to suspend pulling guns for 'feather touch', operation.
- Frees the operator from handling weight of the gun, allowing him to concentrate on the tube pulling operation.

Model	Balancer Range		For Pulling Gun Model	Weight	
	KGS.	LBS.		KGS.	LBS.
BSEW-22	15-22	33-48	SHPG-15	8.0	17.6
BSEW-30	22-30	48-66	SHPG-30	9.0	19.8
BSEW-60	50-60	110-132	SHPG-45	12.0	26.4

To view demo of above machine please visit our below youtube link <https://youtu.be/ypol-z0YhS0>
(If you cannot click below then either copy and paste the same in the browser or scan below QR code)



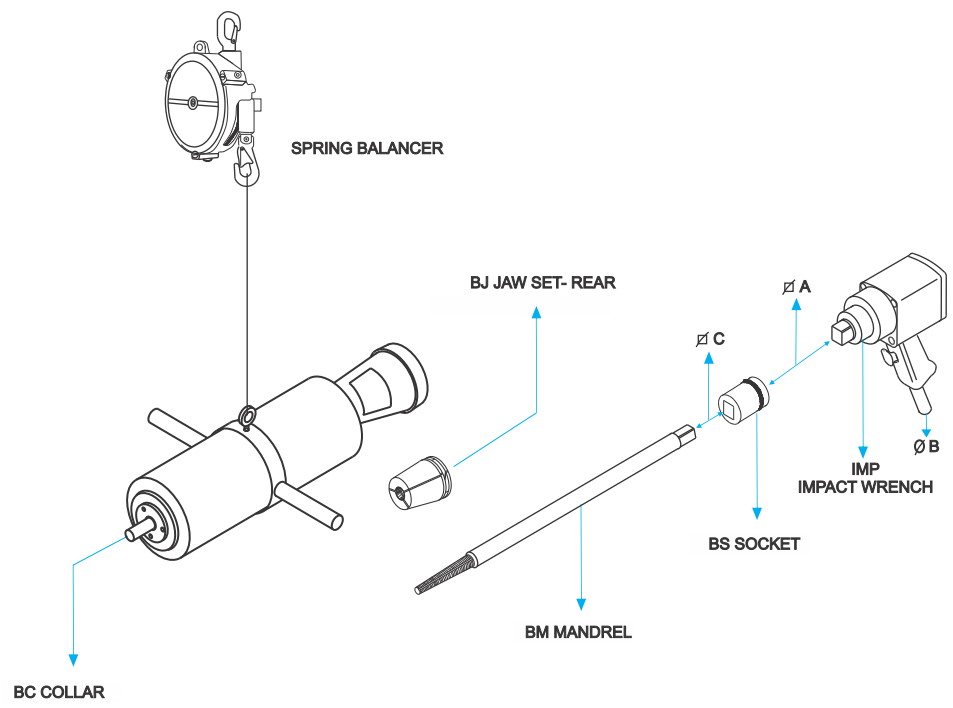

IMP - IMPACT WRENCH

- Used to thread BM mandrels into tube with help of sockets.

Model	Suited For Mandrel Model Numbers	Weight		A	B
		KGS.	LBS.		
IMP-1	BM-7 to BM-37	5.0	11.0	3/4"	3/8"
IMP-1	BM-19 to BM-95/102	10.5	23.0	1"	1/2"

BS - SOCKET

- Used to connect impact wrench to pulling mandrel.

Model	A	B	Model	A	B
BS-1	3/4"	3/8"	BS-5	3/4"	1"
BS-2	3/4"	1 1/2"	BS-6	1"	3/4"
BS-3	3/4"	5/8"	BS-7	1"	1"
BS-4	3/4"	3/4"	BS-8	1"	1.1/2"

WORKING CONSUMABLES - MASTER TUGGER HYDRAULIC TUBE PULLER

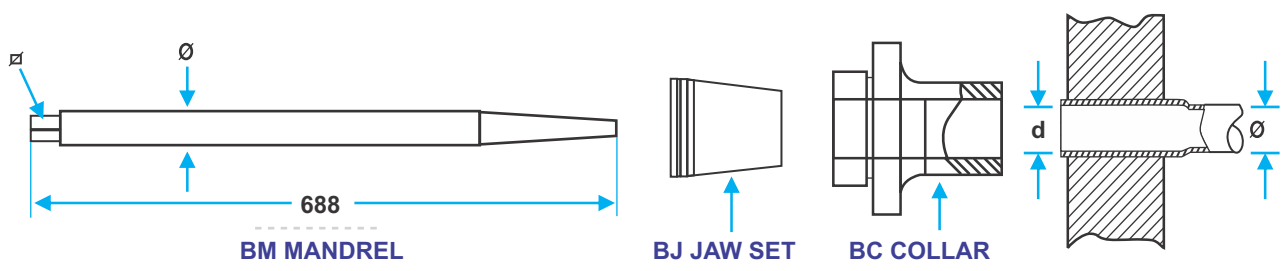

Note : Working Consumables - Master Tugger Hydraulic Tube Puller (HTP) has consumable such as Pulling Mandrel, Rear Jaw set and Collar. Different sizes of pulling mandrels and other consumables are required for different pulling gun of model SHPG-15, SHPG-16, SHPG-30, SHPG-45.

For different size of consumable and their model numbers, please contact us....

OUR MAJOR CLIENTS

Please see below our robust and valued client list that uses BHARTIYA products repeatedly. We take pride in our partnerships and the ability to grow with such amazing group of companies.



SHINGARE
INDUSTRIES PVT LTD

SHINGARE INDUSTRIES PVT. LTD.
Formerly known as Bharatiya Industries

Manufacturer & Exporter of Tube Cleaners, Flexible Shafts, Tube Tools, Impact Sockets, Bolting Tools, Pipe Cold Cutting and Beveling Machines, Torque Tools, Grinding Tools, Tapping Tools, Hydraulic Torque Wrench, Electric Torque Wrench, Manual Torque Wrench & Torque Multiplier

Factory Add: A-48 B Osiya Mataji Compound, Village Kalher, Retibunder Road, Tal. Bhiwandi, Dist. Thane - 421302, Maharashtra.

Hade Off: A-104, 1st Floor, Eastern Business District (Magnet/Neptune Mall), L.B.S. Marg, Bhandup (west), Mumbai - 40078.

+91 77188 96512 | + 91 90290 05461 | bharatflex@yahoo.com | spradip@tubecleaner.co.in

www.shingare.com | www.tubecleaner.co.in